

2022 Product Catalog



www.uniarch.cn

Sales: overseasbusiness@uniview.com

Technical Support: globalsupport@uniview.com

2022.07 OM-220701-TB-V1.0

Disclaimer: All rights reserved, including final interpretation and content amend



About Uniarch

Uniarch is a new brand created by Uniview Technologies.

With more than 10 years of experience and technology accumulation, we provides easy-to-use and cost-effective products in Uniarch, ranging from IP security system to video conference devices, for home and SMB business worldwide.

Uniarch is founded with the vision to create environments where people and businesses are able to achieve more.

Since then, we've become a global provider committed to delivering technology-driven products and solutions, and building a community for people to connect.

Product Line: CCTV, smart office, display etc.

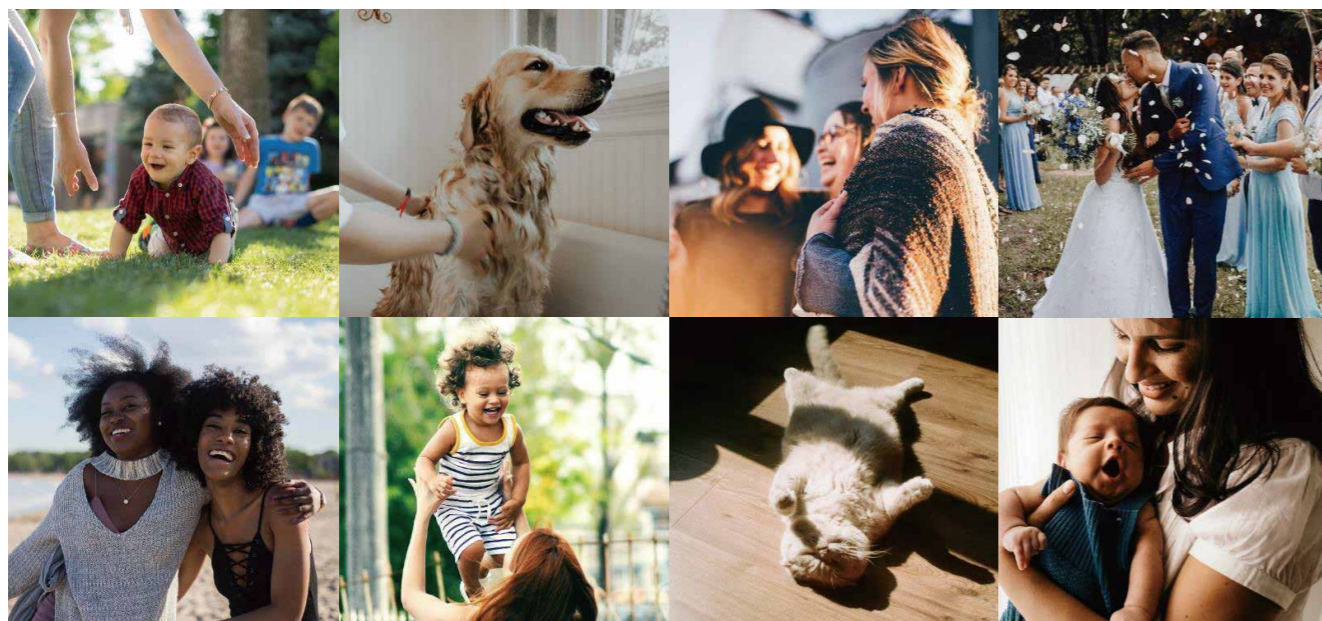

Mission

With its “Life in focus” in mind, Uniarch is paving the way for the changes: to achieve that, we make effort in transforming people’s day to day lives, as well as businesses of every size.

Via optimizing for ease of use, we leave rooms for what’s matter the most. By business empowerment, we entail creating an environment that fosters growth.

Uniarch envisions a world where enables everyone to a fulfilling life.

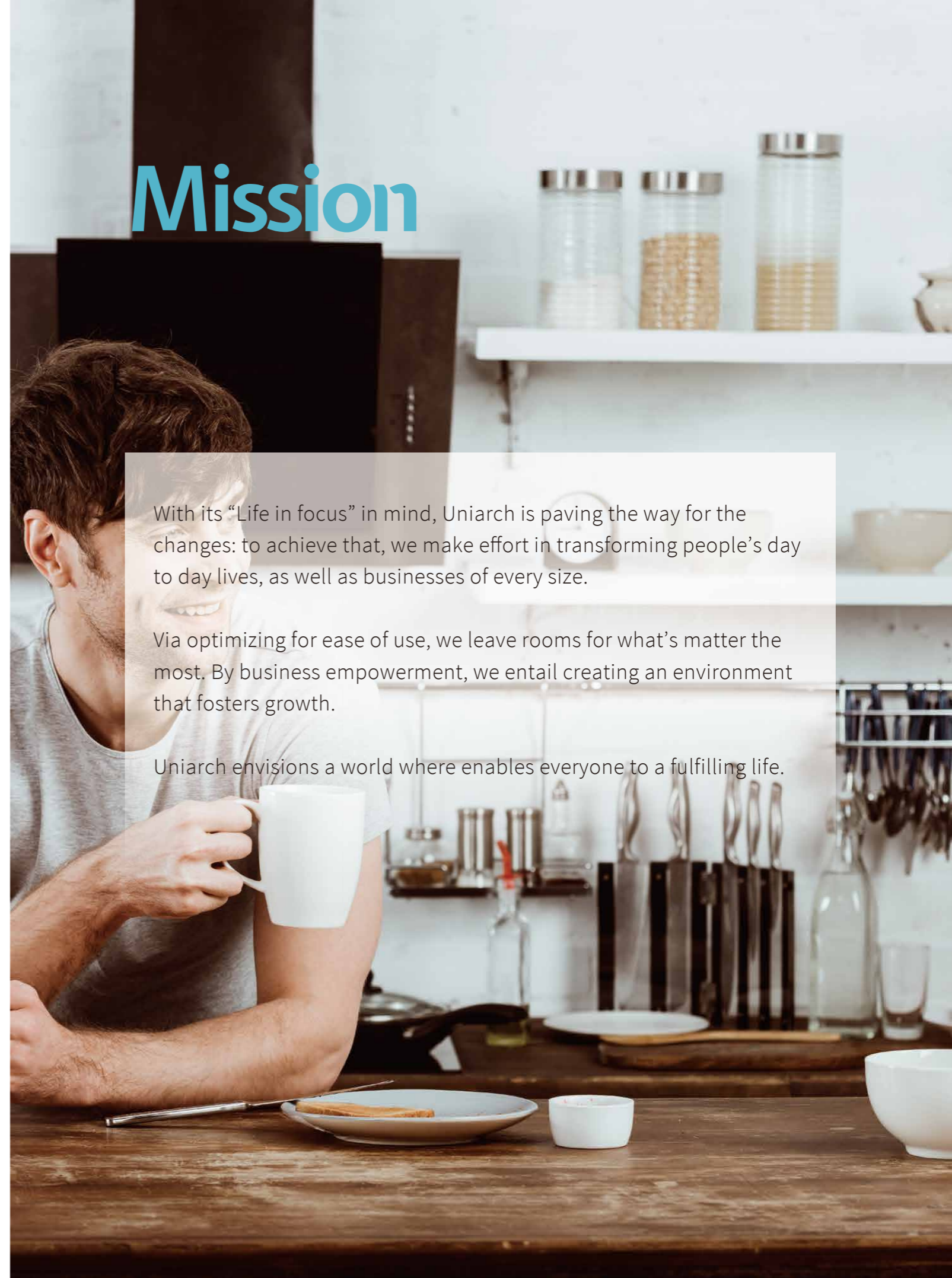



CONTENT

Network Camera

07 | Infrared camera

29 | Dual-light camera

PTZ Camera

30 | Infrared camera

31 | Dual-light camera

Smart Home Camera

32 | Pan & Tilt camera

Video Recorder

35 | NVR

42 | XVR

Display

43 | LED

Transmission

45 | Switch

47 | Network cables

Video Conferencing Device

51 | All-in-one device

56 | Webcam

CCTV Product

- Uniarch is your best choice in a competitive market. With advanced industrial chain, Uniarch continues to enrich and iterate the product layout. In endless pursuit of quality & safety, Uniarch carried out products that are super easy to use.
- In order to satisfy the market demand, Uniarch attaches great importance on innovation and developed dual-light technology, introduced the dual light cameras which changes post-query into pre-prevention before events happen.

Endless Quality & Safety Pursuit

<p>Anti-reflection</p> <p>Increase the infrared transmittance as 8%</p>	<p>Wide temperature</p> <p>Extreme operation temperature test for all outdoor products</p>	<p>Wide voltage</p> <p>±25%</p> <p>voltage tolerance Ideal for power instability</p>
<p>IP67 & IK10</p> <p>IP67 water proof IK10 Vandal proof</p>	<p>Retrieve password</p> <p>Find back the password by temporary password by E-mail</p>	<p>Cyber security</p> <p>Data protection Video encryption, HTTPS Limited access ARP protection, shutdown unsafe service Identity authentication Strong & weak password, 802.1x, RTSP, Onvif</p>

Easy to Use, Smooth to Replace

<p>One-click update</p> <p>Upgrade completed with one-click based on Cloud</p>	<p>Fast dismounting</p> <p>Align marks on the base and body then easily dismount the device</p>	<p>ONVIF full member</p> <p>Onvif (Profile S/T), LAPI and SDK</p>
<p>Plug & Play</p> <p>Just connect cables and power on. ZERO extra manpower cost.</p>	<p>Audio over coaxial</p> <p>Minimize the amount of cabling needed</p>	<p>Cloud device management</p> <p>One click to access web interface of devices over cloud service</p>

Star Product: Infrared Fixed-lens Network Camera



Key features

- 2/4/5 MP
- Built-in Mic
- Night vision with smart IR
- Motion detection
- IP67 and IK10 ingress protection

Application scenarios



Restaurant House Yard

Infrared cameras Offer high performance with lower cost, which make it an ideal choice for entry-level market

Easy to use

Update  Built in mic 

One-click upgrade  Pick up ambient sound for an extra layer of security

Star Product: Smart Pan & Tilt Camera



Key features

- 2MP, 1/3" CMOS sensor
- Two-way audio
- Night vision with smart IR
- Motion detection
- Support Micro SD cards
- 2.4 GHz Wi-Fi

Application scenarios

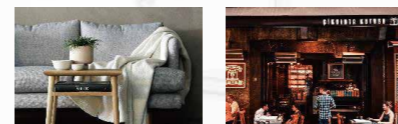

Apartment Retail

Free to place camera on a shelf or fix it to your wall or ceiling

Easy to use



Set up in minutes by simply downloading the app and connecting the camera to Wi-Fi/Ethernet

Cyber security

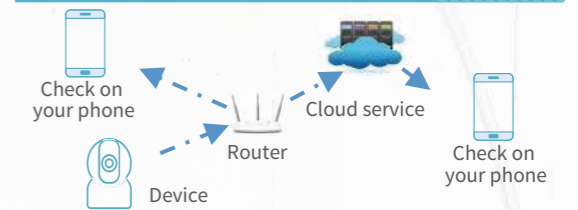





Data protection:
GDPR, Video encryption, https

Budget friendly



Do more with less



Endless quality pursuit



 Stability test  Image test

 Lens test  Scene test

Feature-rich

 Digital zoom  Smart IR

 Motion detection  AI function

 Smart tracking  Remote viewing

Guarantee the **hardware**
Take more advantage of the **software**

Star Product: Dual-light Bullet Camera



Key features

- 3MP, 1/2.8" CMOS sensor
- Dual-light technology
- Up to 50m supplement light distance
- Built in mic
- Three supplement lights mode
- IP67 ingress protection

Application scenarios



Fish ponds



orchards



Retail

Dual-light bullet camera can be applied in wider scenarios where colorful images and additional deterrent are necessary

Advanced hardware



Built in mic

Provide richer details and restore the real scene

4 warm lights and 2 infrared lights

Smart function



Human body detection

Detect the person and marked with a rectangle

Smart dual-light mode



IR mode

Turn on infrared light, trigger warm light shinning when preset are detected

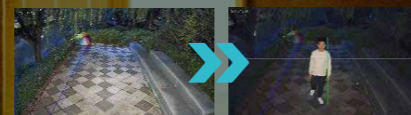

Warm light mode

Turn on warm lights, automatically adjust the brightness for clear image



Dual light mode

Switch from infrared lights to warm lights when the preset are detected

Star Product: Dual-light PT Camera (Coming Soon)



Key features

- 3MP, 1/2.8" CMOS sensor
- Dual-light technology
- Up to 30m supplement light distance
- Built in mic and speaker
- Three supplement lights mode
- IP66 ingress protection

Application scenarios



Yard



Retail



Warehouse

Dual-light PT camera can be applied in wider scenarios where colorful images and addition deterrent are necessary

Advanced hardware



Integrated bracket

Easy to install

Integrated bracket support wall mounting and ceiling

Built in speaker

6 white lights and 2 infrared lights

Built in mic



Smart dual-light mode

- Intrusion detection (Based on human)
- Three dual-light mode



IR mode: IR on **Trigger** WL flicker

WL mode: WL on **Trigger** WL on

Dual-light: IR on **Trigger** WL on

2MP Mini Fixed Bullet Network Camera

IPC-B122-APF28(40)



Key Features

Optics

- Day/night functionality
- Smart IR, up to 30m (98ft) IR distance
- Optical glass window with higher light transmittance
- IR anti-reflection window to increase the infrared transmittance
- 2D/3D DNR (Digital Noise Reduction)
- Built-in Mic

Compression

- Ultra 265, H.265, H.264
- ROI (Region of Interest)

Network

- ONVIF Conformance

Structure

- Wide temperature range: -30°C ~ 60°C (-22°F ~ 140°F)
- Wide voltage range of ±25%
- IP67

Dimensions

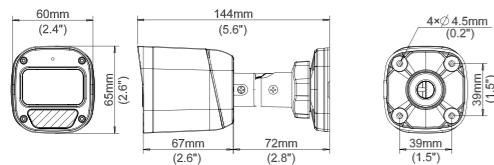

Specifications

	IPC-B122-APF28	IPC-B122-APF40			
Camera					
Sensor	1/2.8", progressive scan, CMOS				
Lens	2.8mm@F2.1	4.0mm@F2.1			
DORI Distance	Lens (mm)	Detect (m)	Observe (m)	Recognize (m)	Identify (m)
	2.8	43.4	17.4	8.7	4.3
	4.0	62.1	24.8	12.4	6.2
Angle of View (H)	106.7°		87.5°		
Angle of View (V)	57.1°		46.3°		
Angle of View (O)	115.7°		92.4°		
Adjustment angle	Pan: 0° ~ 360°	Tilt: 0° ~ 90°	Rotate: 0° ~ 360°		
Shutter	Auto/Manual, 1 ~ 1/100000s				
Minimum Illumination	Colour: 0.02Lux (F2.1, AGC ON) 0Lux with IR on				
Digital noise reduction	2D/3D DNR				
Day/Night	IR-cut filter with auto switch (ICR)				
S/N	>52dB				
IR Range	Up to 30m (98ft) IR range				
Defog	Digital Defog				
WDR	DWDR				
Video					
Video Compression	Ultra 265, H.265, H.264				
H.264 code profile	Baseline profile, Main Profile, High profile				
Frame Rate	Main Stream: 1080P (1920*1080), Max 25fps; 720P (1280*720), Max 25fps; Sub Stream: 720P (1280*720), Max 25fps; D1 (720*576), Max 25fps; 640*360, Max 25fps; 2CIF (704*288), Max 25fps; CIF (352*288), Max 25fps;				
HLC	Supported				
BLC	Supported				
OSD	Up to 4 OSDs				
Privacy Mask	Up to 4 areas				
ROI	Up to 8 areas				
Motion Detection	Up to 4 areas				
Network					
Protocols	IPv4, IGMP, ICMP, TCP, UDP, DHCP, RTP, RTSP, RTCP, DNS, DDNS, NTP, UPnP, HTTP, RTMP				
Compatible Integration	ONVIF (Profile S, Profile T), API				
Interface					
Network	10/100M Base-TX Ethernet				
Built-in Mic	Supported				
General					
Power	DC 12V±25%, PoE Power consumption: Max 3.5W				
Dimensions (L × W × H)	144 × 60 × 65mm (5.6" × 2.4" × 2.6")				
Weight	0.17kg (0.37lb)				
Working Environment	-30°C ~ 60°C (-22°F ~ 140°F), Humidity: ≤95% RH (non-condensing)				
Ingress Protection	IP67				

2MP Vandal-resistant Network IR Fixed Dome Camera

IPC-D122-PF28(40)



Key Features

Optics

- Day/night functionality
- Smart IR, up to 30m (98ft) IR distance
- 2D/3D DNR (Digital Noise Reduction)

Compression

- Ultra 265, H.265, H.264
- ROI (Region of Interest)

Network

- ONVIF Conformance

Structure

- Wide temperature range: -30°C ~ 60°C (-22°F ~ 140°F)
- Wide voltage range of ±25%
- IK10 vandal resistant
- IP67
- 2-Axis

Dimensions

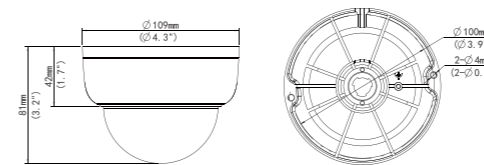

Specifications

	IPC-D122-PF28	IPC-D122-PF40			
Camera					
Sensor	1/2.8", progressive scan, CMOS				
Lens	2.8mm@F2.1	4.0mm@F2.1			
DORI Distance	Lens (mm)	Detect (m)	Observe (m)	Recognize (m)	Identify (m)
	2.8	43.4	17.4	8.7	4.3
	4.0	62.1	24.8	12.4	6.2
Angle of View (H)	106.7°		87.5°		
Angle of View (V)	57.1°		46.3°		
Angle of View (O)	115.7°		92.4°		
Adjustment angle	Pan: 3° ~ 360°		Tilt: 0° ~ 75°		
Shutter	Auto/Manual, 1 ~ 1/100000s				
Minimum Illumination	Colour: 0.02Lux (F2.1, AGC ON) 0Lux with IR				
Day/Night	IR-cut filter with auto switch (ICR)				
Digital noise reduction	2D/3D DNR				
S/N	>52dB				
IR Range	Up to 30m (98ft) IR range				
Defog	Digital Defog				
WDR	DWDR				
Video					
Video Compression	Ultra 265, H.265, H.264				
H.264 code profile	Baseline profile, Main Profile, High profile				
Frame Rate	Main Stream: 1080P (1920*1080), Max 25fps; 720P (1280*720), Max 25fps; Sub Stream: 720P (1280*720), Max 25fps; D1 (720*576), Max 25fps; 640*360, Max 25fps; 2CIF (704*288), Max 25fps; CIF (352*288), Max 25fps;				
HLC	Supported				
BLC	Supported				
OSD	Up to 4 OSDs				
Privacy Mask	Up to 4 areas				
ROI	Up to 8 areas				
Motion Detection	Up to 4 areas				
Network					
Protocols	IPv4, IGMP, ICMP, TCP, UDP, DHCP, RTP, RTSP, RTCP, DNS, DDNS, NTP, UPnP, HTTP, RTMP				
Compatible Integration	ONVIF (Profile S, Profile T), API				
Interface					
Network	10/100M Base-TX Ethernet				
General					
Power	DC 12V±25%, PoE Power consumption: Max 3.5W				
Dimensions (Ø x H)	Ø 109x 81mm (Ø4.3" x 3.2")				
Weight	0.33kg (0.73lb)				
Working Environment	-30°C ~ 60°C (-22°F ~ 140°F), Humidity: ≤95% RH (non-condensing)				
Ingress Protection	IP67				
Ingress Protection	IK10				

2MP Fixed Eyeball Network Camera

IPC-T122-APF28(40)



Key Features

Opticsx

- Day/night functionality
- Smart IR, up to 30m (98ft) IR distance
- 2D/3D DNR (Digital Noise Reduction)
- Built-in Mic

Compression

- Ultra 265, H.265, H.264
- ROI (Region of Interest)

Network

- ONVIF Conformance

Structure

- Wide temperature range: -30°C ~ 60°C (-22°F ~ 140°F)
- Wide voltage range of ±25%
- IP67
- 3-Axis

Dimensions

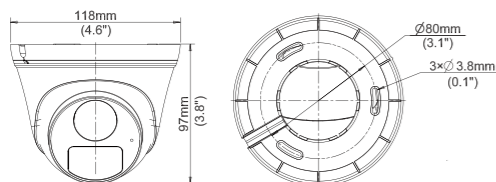

Specifications

	IPC-T122-APF28	IPC-T122-APF40			
Camera					
Sensor	1/2.8", progressive scan, CMOS				
Lens	2.8mm@F2.1		4.0mm@F2.1		
DORI Distance	Lens (mm)	Detect (m)	Observe (m)	Recognize (m)	Identify (m)
	2.8	43.4	17.4	8.7	4.3
	4.0	62.1	24.8	12.4	6.2
Angle of View (H)	106.7°		87.5°		
Angle of View (V)	57.1°		46.3°		
Angle of View (O)	115.7°		92.4°		
Adjustment angle	Pan: 0° ~ 360°		Tilt: 0° ~ 80°	Rotate: 0° ~ 360°	
Shutter	Auto/Manual, 1 ~ 1/100000s				
Minimum Illumination	Colour: 0.02Lux (F2.1, AGC ON) 0Lux with IR				
Day/Night	IR-cut filter with auto switch (ICR)				
Digital noise reduction	2D/3D DNR				
S/N	>52dB				
IR Range	Up to 30m (98ft) IR range				
Defog	Digital Defog				
WDR	DWDR				
Video					
Video Compression	Ultra 265, H.265, H.264				
H.264 code profile	Baseline profile, Main Profile, High profile				
Frame Rate	Main Stream: 1080P (1920*1080), Max 25fps; 720P (1280*720), Max 25fps; Sub Stream: 720P (1280*720), Max 25fps; D1 (720*576), Max 25fps; 640*360, Max 25fps; 2CIF (704*288), Max 25fps; CIF (352*288), Max 25fps;				
HLC	Supported				
BLC	Supported				
OSD	Up to 4 OSDs				
Privacy Mask	Up to 4 areas				
ROI	Up to 8 areas				
Motion Detection	Up to 4 areas				
Network					
Protocols	IPv4, IGMP, ICMP, TCP, UDP, DHCP, RTP, RTSP, RTCP, DNS, DDNS, NTP, UPnP, HTTP, RTMP				
Compatible Integration	ONVIF (Profile S, Profile T), API				
Interface					
Network	10/100M Base-TX Ethernet				
Built-in Mic	Supported				
General					
Power	DC 12V±25%, PoE Power consumption: Max 3.5W				
Dimensions (Ø x H)	Ø 118 x 97mm (Ø4.6" x 3.8")				
Weight	0.25kg (0.55lb)				
Working Environment	-30°C ~ 60°C (-22°F ~ 140°F), Humidity: ≤95% RH (non-condensing)				
Ingress Protection	IP67				

2MP Bullet Network Camera

IPC-B222-APF40



Key Features

Optics

- Day/night functionality
- Smart IR, up to 60m (196ft) IR distance
- Optical glass window with higher light transmittance
- IR anti-reflection window to increase the infrared transmittance
- 2D/3D DNR (Digital Noise Reduction)
- Built-in Mic

Compression

- H.265, H.264
- ROI (Region of Interest)

Network

- ONVIF Conformance

Structure

- Wide temperature range: -30°C ~ 60°C (-22°F ~ 140°F)
- Wide voltage range of DC12V(±25%)
- IP67

Dimensions

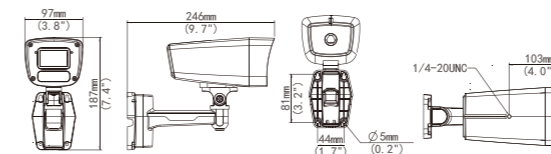

Specifications

	IPC-B222-APF40
Camera	
Sensor	1/3", progressive scan, CMOS
Minimum Illumination	Colour: 0.02 (F2.3, AGC ON) 0Lux with IR on
WDR	DWDR
Lens	
Lens Type	4.0mm @2.3, Fixed-focal
Field of View (H)	80.2°
Field of View (V)	42.9°
Field of View (D)	86.0°
Illuminator	
IR Range	Up to 60m (196ft) IR range
Video	
Video Compression	H.265, H.264
H.264 code profile	Baseline profile, Main profile, High profile
Frame Rate	Main Stream: 2MP (1920*1080), Max 25fps; 720P (1280*720), Max 25fps; Sub Stream: D1 (720*576), Max 25fps; 640*360, Max 25fps; 2CIF (704*288), Max 25fps; CIF (352*288), Max 25fps;
Image	
White Balance	Auto/Outdoor/Fine Tune/Sodium Lamp/Locked/Auto2
Digital Noise Reduction	2D/3D DNR
Smart IR	Supported
HLC	Supported
BLC	Supported
Defog	Digital Defog
Events	
Basic Detection	motion detection, audio detection
General Function	Watermark, IP address filtering, access policy, ARP protection, RTSP authentication, user authentication, HTTP authentication
Network	
Protocols	IPv4, IGMP, ICMP, TCP, UDP, DHCP, RTP, RTSP, RTCP, DNS, DDNS, NTP, UPnP, HTTP, RTMP
Compatible Integration	ONVIF (Profile S, Profile T), API
Client	Uniarch Client Uniarch APP
Interface	
Network	1 * RJ45 10M/100M Base-TX Ethernet
Built-in Mic	Supported
Certifications	
Protection	IP67

3MP Mini Fixed Bullet Network Camera

IPC-B123-AF28-A



Key Features

Optics

- Day/night functionality
- Smart IR, up to 30m (98ft) IR distance
- Optical glass window with higher light transmittance
- IR anti-reflection window to increase the infrared transmittance
- 2D/3D DNR (Digital Noise Reduction)
- Built-in Mic

Compression

- Ultra 265, H.265, H.264
- ROI (Region of Interest)

Network

- ONVIF Conformance

Structure

- Wide temperature range: -30°C ~ 60°C (-22°F ~ 140°F)
- Wide voltage range of ±25%
- IP67

Dimensions

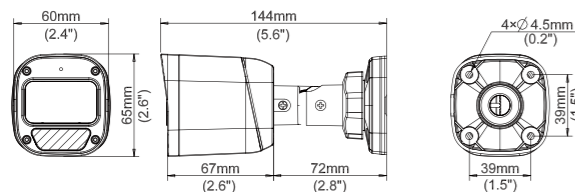

Specifications

IPC-B123-AF28-A					
Camera					
Sensor	1/2.8", progressive scan, CMOS				
Lens	2.8mm@F2.1				
DORI Distance	Lens (mm)	Detect (m)	Observe (m)	Recognize (m)	Identify (m)
	2.8	51.4	20.6	10.3	5.1
Angle of View (H)	109.2°				
Angle of View (V)	57.9°				
Angle of View (O)	117.8°				
Adjustment angle	Pan: 0° ~ 360°		Tilt: 0° ~ 90°		Rotate: 0° ~ 360°
	Shutter				
	Auto/Manual, 1 ~ 1/1000000s				
Minimum Illumination	Colour: 0.01Lux (F2.1, AGC ON) 0Lux with IR on				
Digital noise reduction	2D/3D DNR				
Day/Night	IR-cut filter with auto switch (ICR)				
S/N	>52dB				
IR Range	Up to 30m (98ft) IR range				
Defog	Digital Defog				
WDR	DWDR				
Video					
Video Compression	Ultra 265, H.265, H.264				
H.264 code profile	Baseline profile, Main profile, High profile				
Frame Rate	Main Stream: 3MP (2304*1296), Max 20fps;1080P (1920*1080), Max 30fps; 720P (1280*720), Max 30fps; Sub Stream: 4CIF (704*576), Max 30fps; 640*360, Max 30fps; 2CIF(704*288), Max 30fps; CIF(352*288), Max 30fps;				
HLC	Supported				
BLC	Supported				
OSD	Up to 4 OSDs				
Privacy Mask	Up to 4 areas				
ROI	Up to 8 areas				
Motion Detection	Up to 4 areas				
Network					
Protocols	IPv4, IGMP, ICMP, TCP, UDP, DHCP, RTP, RTSP, RTCP, DNS, DDNS, NTP, UPnP, HTTP, RTMP				
Compatible Integration	ONVIF (Profile S, Profile T), API				
Interface					
Network	10/100M Base-TX Ethernet				
Built-in Mic	Supported				
General					
Power	DC 12V±25%				
	Power consumption: Max 3.5W				
Dimensions (L × W × H)	144 × 60 × 65mm (5.6" × 2.4" × 2.6")				
Weight	0.17kg (0.37lb)				
Working Environment	-30°C ~ 60°C (-22°F ~ 140°F), Humidity: ≤95% RH (non-condensing)				
Surge Protection	4KV				
Ingress Protection	IP67				
Reset Button	N/A				

3MP Vandal-resistant Network IR Fixed Dome Camera

IPC-D123-F28-A



Key Features

Optics

- Day/night functionality
- Smart IR, up to 30m (98ft) IR distance
- 2D/3D DNR (Digital Noise Reduction)

Compression

- Ultra 265, H.265, H.264
- ROI (Region of Interest)

Network

- ONVIF Conformance

Structure

- Wide temperature range: -30°C ~ 60°C (-22°F ~ 140°F)
- Wide voltage range of ±25%
- IK10 vandal resistant
- IP67
- 2-Axis

Dimensions

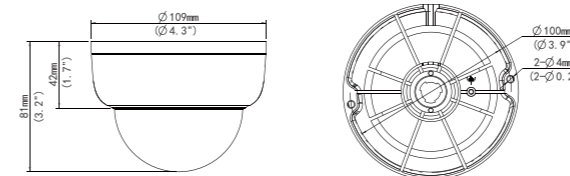

Specifications

IPC-D123-F28-A					
Camera					
Sensor	1/2.8", progressive scan, CMOS				
Lens	2.8mm@F2.1				
DORI Distance	Lens (mm)	Detect (m)	Observe (m)	Recognize (m)	Identify (m)
	2.8	51.4	20.6	10.3	5.1
Angle of View (H)	109.2°				
Angle of View (V)	57.9°				
Angle of View (O)	117.8°				
Adjustment angle	Pan: 8° ~ 360°			Tilt: 0° ~ 75°	
	Shutter				
Auto/Manual, 1 ~ 1/1000000s					
Minimum Illumination	Colour: 0.01Lux (F2.1, AGC ON) 0Lux with IR				
Digital noise reduction	IR-cut filter with auto switch (ICR)				
Day/Night	2D/3D DNR				
S/N	>52dB				
IR Range	Up to 30m (98ft) IR range				
Defog	Digital Defog				
WDR	DWDR				
Video					
Video Compression	Ultra 265, H.265, H.264				
H.264 code profile	Baseline profile, Main profile, High profile				
Frame Rate	Main Stream: 3MP (2304*1296), Max 20fps;1080P (1920*1080), Max 30fps; 720P (1280*720), Max 30fps; Sub Stream: 4CIF (704*576), Max 30fps; 640*360, Max 30fps; 2CIF(704*288), Max 30fps; CIF(352*288), Max 30fps;				
HLC	Supported				
BLC	Supported				
OSD	Up to 4 OSDs				
Privacy Mask	Up to 4 areas				
ROI	Up to 8 areas				
Motion Detection	Up to 4 areas				
Network					
Protocols	IPv4, IGMP, ICMP, TCP, UDP, DHCP, RTP, RTSP, RTCP, DNS, DDNS, NTP, UPnP, HTTP, RTMP				
Compatible Integration	ONVIF (Profile S, Profile T), API				
Interface					
Network	10/100M Base-TX Ethernet				
General					
Power	DC 12V±25%				
	Power consumption: Max 3.5W				
Dimensions (Ø x H)	Ø109x 81mm (Ø4.3" x 3.2")				
Weight	0.33kg (0.73lb)				
Working Environment	-30°C ~ 60°C (-22°F ~ 140°F), Humidity: ≤95% RH (non-condensing)				
Surge Protection	4KV				
Ingress Protection	IP67				
Vandal Resistant	IK10				
Reset Button	N/A				

3MP Fixed Eyeball Network Camera

IPC-T123-AF28-A



Key Features

Optics

- Day/night functionality
- Smart IR, up to 30m (98ft) IR distance
- 2D/3D DNR (Digital Noise Reduction)
- Built-in Mic

Compression

- Ultra 265, H.265, H.264
- ROI (Region of Interest)

Network

- ONVIF Conformance

Structure

- Wide temperature range: -30°C ~ 60°C (-22°F ~ 140°F)
- Wide voltage range of ±25%
- IP67
- 3-Axis

Dimensions

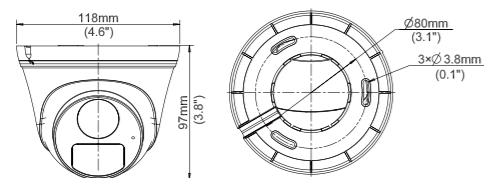

Specifications

IPC-T123-AF28-A					
Camera					
Sensor	1/2.8", progressive scan, CMOS				
Lens	2.8mm@F2.1				
DORI Distance	Lens (mm)	Detect (m)	Observe (m)	Recognize (m)	Identify (m)
	2.8	51.4	20.6	10.3	5.1
Angle of View (H)	109.2°				
Angle of View (V)	57.9°				
Angle of View (O)	117.8°				
Adjustment angle	Pan: 0° ~ 360°	Tilt: 0° ~ 75°	Rotate: 0° ~ 360°		
Shutter	Auto/Manual, 1 ~ 1/100000s				
Minimum Illumination	Colour: 0.01Lux (F2.1, AGC ON) 0Lux with IR				
Digital noise reduction	IR-cut filter with auto switch (ICR)				
Day/Night	2D/3D DNR				
S/N	>52dB				
IR Range	Up to 30m (98ft) IR range				
Defog	Digital Defog				
WDR	DWDR				
Video					
Video Compression	Ultra 265, H.265, H.264				
H.264 code profile	Baseline profile, Main profile, High profile				
Frame Rate	Main Stream: 3MP (2304*1296), Max 20fps; 1080P (1920*1080), Max 30fps; 720P (1280*720), Max 30fps; Sub Stream: 4CIF (704*576), Max 30fps; 640*360, Max 30fps; 2CIF (704*288), Max 30fps; CIF (352*288), Max 30fps;				
HLC	Supported				
BLC	Supported				
OSD	Up to 4 OSDs				
Privacy Mask	Up to 4 areas				
ROI	Up to 8 areas				
Motion Detection	Up to 4 areas				
Network					
Protocols	IPv4, IGMP, ICMP, TCP, UDP, DHCP, RTP, RTSP, RTCP, DNS, DDNS, NTP, UPnP, HTTP, RTMP				
Compatible Integration	ONVIF (Profile S, Profile T), API				
Interface					
Network	10/100M Base-TX Ethernet				
Built-in Mic	Supported				
General					
Power	DC 12V±25% Power consumption: Max 3.5W				
Dimensions (Ø x H)	Ø118 x 97mm (Ø4.6" x 3.8")				
Weight	0.27kg (0.60lb)				
Working Environment	-30°C ~ 60°C (-22°F ~ 140°F), Humidity: ≤95% RH (non-condensing)				
Surge Protection	4KV				
Ingress Protection	IP67				
Reset Button	N/A				

4MP Mini Fixed Bullet Network Camera

IPC-B124-APF28(40)



Key Features

Optics

- Day/night functionality
- Smart IR, up to 30m (98ft) IR distance
- Optical glass window with higher light transmittance
- IR anti-reflection window to increase the infrared transmittance
- 2D/3D DNR (Digital Noise Reduction)
- Built-in Mic

Compression

- Ultra 265, H.265, H.264, MJPEG
- ROI (Region of Interest)

Network

- ONVIF Conformance

Structure

- Wide temperature range: -30°C ~ 60°C (-22°F ~ 140°F)
- Wide voltage range of ±25%
- IP67

Dimensions

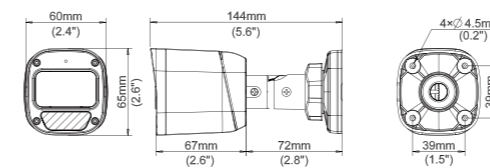

Specifications

	IPC-B124-APF28	IPC-B124-APF40			
Camera					
Sensor	1/3", progressive scan, CMOS				
Lens	2.8mm@F2.1	4.0mm@F2.1			
DORI Distance	Lens (mm)	Detect (m)	Observe (m)	Recognize (m)	Identify (m)
	2.8	63.0	25.2	12.6	6.3
	4.0	90.0	36.0	18.0	9.0
Angle of View (H)	97.0°		79.0°		
Angle of View (V)	52.2°		42.3°		
Angle of View (O)	107.5°		85.1°		
Adjustment angle	Pan: 0° ~ 360°	Tilt: 0° ~ 90°	Rotate: 0° ~ 360°		
Shutter	Auto/Manual, 1 ~ 1/100000s				
Minimum Illumination	Colour: 0.02Lux (F2.1, AGC ON) 0Lux with IR on				
Digital noise reduction	2D/3D DNR				
Day/Night	IR-cut filter with auto switch (ICR)				
S/N	>52dB				
IR Range	Up to 30m (98ft) IR range				
Defog	Digital Defog				
WDR	DWDR				
Video					
Video Compression	Ultra 265, H.265, H.264				
H.264 code profile	Baseline profile, Main Profile, High profile				
Frame Rate	Main Stream: 4MP (2560*1440), Max 20fps; 3MP (2304*1296), Max 20fps; 1080P (1920*1080), Max 30fps; Sub Stream: 720P (1280*720), Max 30fps; D1 (720*576), Max 30fps; 640*360, Max 30fps; 2CIF (704*288), Max 30fps; CIF (352*288), Max 30fps;				
HLC	Supported				
BLC	Supported				
OSD	Up to 4 OSDs				
Privacy Mask	Up to 4 areas				
ROI	Up to 8 areas				
Motion Detection	Up to 4 areas				
Network					
Protocols	IPv4, IGMP, ICMP, ARP, TCP, UDP, DHCP, RTP, RTSP, RTCP, DNS, DDNS, NTP, FTP, UPnP, HTTP, HTTPS, SMTP, SSL, QoS, RTMP				
Compatible Integration	ONVIF (Profile S, Profile T), API				
Interface					
Network	10/100M Base-TX Ethernet				
Built-in Mic	Supported				
General					
Power	DC 12V±25%, PoE Power consumption: Max 3.5W				
Dimensions (L x W x H)	144 x 60 x 65mm (5.6" x 2.4" x 2.6")				
Weight	0.17kg (0.37lb)				
Working Environment	-30°C ~ 60°C (-22°F ~ 140°F), Humidity: ≤95% RH (non-condensing)				
Ingress Protection	IP67				

4MP Vandal-resistant Network IR Fixed Dome Camera

IPC-D124-PF28(40)



Key Features

Optics

- Day/night functionality
- Smart IR, up to 30m (98ft) IR distance
- 2D/3D DNR (Digital Noise Reduction)

Compression

- Ultra 265, H.265, H.264, MJPEG
- ROI (Region of Interest)

Network

- ONVIF Conformance

Structure

- Wide temperature range: -30°C ~ 60°C (-22°F ~ 140°F)
- Wide voltage range of ±25%
- IK10 vandal resistant
- IP67
- 2-Axis

Dimensions

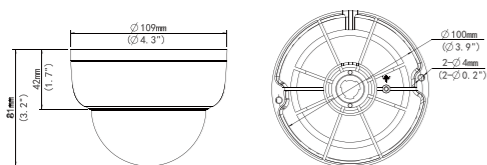

Specifications

	IPC-D124-PF28	IPC-D124-PF40							
Camera									
Sensor	1/3", progressive scan, CMOS								
Lens	2.8mm@F2.1	4.0mm@F2.1							
DORI Distance	Lens (mm)	2.8	63.0	Observe (m)	25.2	Recognize (m)	12.6	Identify (m)	6.3
		4.0	90.0	36.0	18.0	9.0			
Angle of View (H)	97.0°		79.0°						
Angle of View (V)	52.2°		42.3°						
Angle of View (O)	107.5°		85.1°						
Adjustment angle	Pan: 3° ~ 360°		Tilt: 0° ~ 75°						
Shutter	Auto/Manual, 1 ~ 1/100000s								
Minimum Illumination	Colour: 0.02Lux (F2.1, AGC ON) 0Lux with IR on								
Digital noise reduction	2D/3D DNR								
Day/Night	IR-cut filter with auto switch (ICR)								
S/N	>52dB								
IR Range	Up to 30m (98ft) IR range								
Defog	Digital Defog								
WDR	DWDR								
Video									
Video Compression	Ultra 265, H.265, H.264								
H.264 code profile	Baseline profile, Main Profile, High profile								
Frame Rate	Main Stream: 4MP (2560*1440), Max 20fps; 3MP (2304*1296), Max 20fps; 1080P (1920*1080), Max 20fps; Sub Stream: 720P (1280*720), Max 20fps; D1 (720*576), Max 20fps; 640*360, Max 20fps; 2CIF(704*288), Max 20fps; CIF(352*288), Max 20fps;								
HLC	Supported								
BLC	Supported								
OSD	Up to 4 OSDs								
Privacy Mask	Up to 4 areas								
ROI	Up to 8 areas								
Motion Detection	Up to 4 areas								
Network									
Protocols	IPv4, IGMP, ICMP, ARP, TCP, UDP, DHCP, RTP, RTSP, RTCP, DNS, DDNS, NTP, FTP, UPnP, HTTP, HTTPS, SMTP, SSL, QoS, RTMP								
Compatible Integration	ONVIF (Profile S, Profile T), API								
Interface									
Network	10/100M Base-TX Ethernet								
General									
Power	DC 12V±25%, PoE Power consumption: Max 3.5W								
Dimensions (Ø x H)	Ø 109 x 81mm (Ø4.3" x 3.2")								
Weight	0.33kg (0.73lb)								
Working Environment	-30°C ~ 60°C (-22°F ~ 140°F), Humidity: ≤95% RH (non-condensing)								
Ingress Protection	IP67								
Vandal Resistant	IK10								

4MP Fixed Eyeball Network Camera

IPC-T124-APF28(40)



Key Features

Optics

- Day/night functionality
- Smart IR, up to 30m (98ft) IR distance
- 2D/3D DNR (Digital Noise Reduction)
- Built-in Mic

Compression

- Ultra 265, H.265, H.264, MJPEG
- ROI (Region of Interest)

Network

- ONVIF Conformance

Structure

- Wide temperature range: -30°C ~ 60°C (-22°F ~ 140°F)
- Wide voltage range of ±25%
- IP67
- 3-Axis

Dimensions

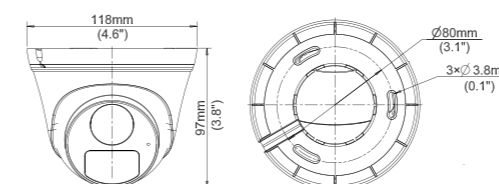

Specifications

	IPC-T124-APF28	IPC-T124-APF40							
Camera									
Sensor	1/3", progressive scan, CMOS								
Lens	2.8mm@F2.1	4.0mm@F2.1							
DORI Distance	Lens (mm)	2.8	63.0	Observe (m)	25.2	Recognize (m)	12.6	Identify (m)	6.3
		4.0	90.0	36.0	18.0	9.0			
Angle of View (H)	97.0°		79.0°						
Angle of View (V)	52.2°		42.3°						
Angle of View (O)	107.5°		85.1°						
Adjustment angle	Pan: 0° ~ 360°	Tilt: 0° ~ 80°	Rotate: 0° ~ 360°						
Shutter	Auto/Manual, 1 ~ 1/100000s								
Minimum Illumination	Colour: 0.02Lux (F2.1, AGC ON) 0Lux with IR on								
Digital noise reduction	2D/3D DNR								
Day/Night	IR-cut filter with auto switch (ICR)								
S/N	>56dB								
IR Range	Up to 30m (98ft) IR range								
Defog	Digital Defog								
WDR	DWDR								
Video									
Video Compression	Ultra 265, H.265, H.264								
H.264 code profile	Baseline profile, Main Profile, High profile								
Frame Rate	Main Stream: 4MP (2560*1440), Max 20fps; 3MP (2304*1296), Max 20fps; 1080P (1920*1080), Max 30fps; Sub Stream: 720P (1280*720), Max 30fps; D1 (720*576), Max 30fps; 640*360, Max 30fps; 2CIF(704*288), Max 30fps; CIF(352*288), Max 30fps;								
HLC	Supported								
BLC	Supported								
OSD	Up to 4 OSDs								
Privacy Mask	Up to 4 areas								
ROI	Up to 8 areas								
Motion Detection	Up to 4 areas								
Network									
Protocols	IPv4, IGMP, ICMP, ARP, TCP, UDP, DHCP, RTP, RTSP, RTCP, DNS, DDNS, NTP, FTP, UPnP, HTTP, HTTPS, SMTP, SSL, QoS, RTMP								
Compatible Integration	ONVIF (Profile S, Profile T), API								
Interface									
Network	10/100M Base-TX Ethernet								
Built-in Mic	Supported								
General									
Power	DC 12V±25%, PoE								
Dimensions (Ø x H)	Ø 118 x 97mm (Ø4.6" x 3.8")								
Weight	0.27kg (0.60lb)								
Working Environment	-30°C ~ 60°C (-22°F ~ 140°F), Humidity: ≤95% RH (non-condensing)								
Ingress Protection	IP67								

5MP Mini Fixed Bullet Network Camera

IPC-B125-APF28(40)



Specifications

	IPC-B125-APF28	IPC-B125-APF40
Camera		
Sensor	1/3", progressive scan, CMOS	
Lens	2.8mm@F2.1 / 4.0mm@F2.1	
DORI Distance	Lens (mm)	Detect (m) / Observe (m) / Recognize (m) / Identify (m)
	2.8	63.0 / 25.2 / 12.6 / 6.3
	4.0	90.0 / 36.0 / 18.0 / 9.0
Adjustment angle	Pan: 0° ~ 360°	Tilt: 0° ~ 90° / Rotate: 0° ~ 360°
Shutter	Auto/Manual, 1 ~ 1/100000s	
Minimum Illumination	Colour: 0.02Lux (F2.1, AGC ON) 0Lux with IR on	
Digital noise reduction	2D/3D DNR	
Day/Night	IR-cut filter with auto switch (ICR)	
S/N	>52dB	
IR Range	Up to 30m (98ft) IR range	
Defog	Digital Defog	
WDR	DWDR	
Video		
Video Compression	Ultra 265, H.265, H.264	
H.264 code profile	Baseline profile, Main Profile, High profile	
Frame Rate	Main Stream: 5MP (2592*1944), Max 20fps; 4MP (2560*1440), Max 20fps; 3MP (2304*1296), Max 20fps; 1080P (1920*1080), Max 30fps; Sub Stream: 720P (1280*720), Max 30fps; D1 (720*576), Max 30fps; 640*360, Max 30fps; 2CIF(704*288), Max 30fps; CIF(352*288), Max 30fps;	
HLC	Supported	
BLC	Supported	
OSD	Up to 4 OSDs	
Privacy Mask	Up to 4 areas	
ROI	Up to 8 areas	
Motion Detection	Up to 4 areas	
Network		
Protocols	IPv4, IGMP, ICMP, ARP, TCP, UDP, DHCP, RTP, RTSP, RTCP, DNS, DDNS, NTP, FTP, UPnP, HTTP, HTTPS, SMTP, SSL, QoS, RTMP	
Compatible Integration	ONVIF (Profile S, Profile T), API	
Interface		
Network	10/100M Base-TX Ethernet	
Built-in Mic	Supported	
General		
Power	DC 12V±25%, PoE	
Dimensions	144 × 60 × 65mm (5.6" × 2.4" × 2.6")	
Weight	0.19kg (0.42lb)	
Working Environment	-30°C ~ 60°C (-22°F ~ 140°F), Humidity: ≤95% RH (non-condensing)	
Ingress Protection	IP67	

Key Features

Optics

- Day/night functionality
- Smart IR, up to 30m (98ft) IR distance
- Optical glass window with higher light transmittance
- IR anti-reflection window to increase the infrared transmittance
- 2D/3D DNR (Digital Noise Reduction)
- Built-in Mic

Compression

- Ultra 265, H.265, H.264, MJPEG
- ROI (Region of Interest)

Network

- ONVIF Conformance

Structure

- Wide temperature range: -30°C ~ 60°C (-22°F ~ 140°F)
- Wide voltage range of ±25%
- IP67

Dimensions

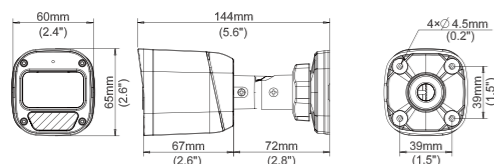

5MP Vandal-resistant Network IR Fixed Dome Camera

IPC-D125-PF28(40)



Specifications

	IPC-D125-PF28	IPC-D125-PF40
Camera		
Sensor	1/3", progressive scan, CMOS	
Lens	2.8mm@F2.1 / 4.0mm@F2.1	
DORI Distance	Lens (mm)	Detect (m) / Observe (m) / Recognize (m) / Identify (m)
	2.8	63.0 / 25.2 / 12.6 / 6.3
	4.0	90.0 / 36.0 / 18.0 / 9.0
Adjustment angle	Pan: 3° ~ 360°	Tilt: 0° ~ 75°
Shutter	Auto/Manual, 1 ~ 1/100000s	
Minimum Illumination	Colour: 0.02Lux (F2.1, AGC ON) 0Lux with IR on	
Digital noise reduction	2D/3D DNR	
Day/Night	IR-cut filter with auto switch (ICR)	
S/N	>52dB	
IR Range	Up to 30m (98ft) IR range	
Defog	Digital Defog	
WDR	DWDR	
Video		
Video Compression	Ultra 265, H.265, H.264	
H.264 code profile	Baseline profile, Main Profile, High profile	
Frame Rate	Main Stream: 5MP (2880*1620), Max 20fps; 4MP (2560*1440), Max 20fps; 3MP (2304*1296), Max 20fps; 1080P (1920*1080), Max 30fps; Sub Stream: 720P (1280*720), Max 30fps; D1 (720*576), Max 30fps; 640*360, Max 30fps; 2CIF(704*288), Max 30fps; CIF(352*288), Max 30fps;	
HLC	Supported	
BLC	Supported	
OSD	Up to 4 OSDs	
Privacy Mask	Up to 4 areas	
ROI	Up to 8 areas	
Motion Detection	Up to 4 areas	
Network		
Protocols	IPv4, IGMP, ICMP, ARP, TCP, UDP, DHCP, RTP, RTSP, RTCP, DNS, DDNS, NTP, FTP, UPnP, HTTP, HTTPS, SMTP, SSL, QoS, RTMP	
Compatible Integration	ONVIF (Profile S, Profile T), API	
Interface		
Network	10/100M Base-TX Ethernet	
General		
Power	DC 12V±25%, PoE	
Dimensions (Ø x H)	Ø 109 x 81mm (Ø4.3" x 3.2")	
Weight	0.33kg (0.73lb)	
Working Environment	-30°C ~ 60°C (-22°F ~ 140°F), Humidity: ≤95% RH (non-condensing)	
Ingress Protection	IP67	
Vandal Resistant	IK10	

Key Features

Optics

- Day/night functionality
- Smart IR, up to 30m (98ft) IR distance
- 2D/3D DNR (Digital Noise Reduction)

Compression

- Ultra 265, H.265, H.264, MJPEG
- ROI (Region of Interest)

Network

- ONVIF Conformance

Structure

- Wide temperature range: -30°C ~ 60°C (-22°F ~ 140°F)
- Wide voltage range of ±25%
- IK10 vandal resistant
- IP67
- 2-Axis

Dimensions

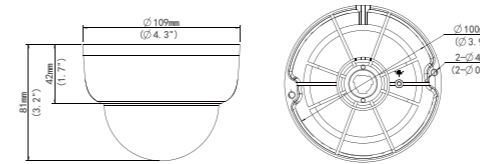

5MP Fixed Eyeball Network Camera

IPC-T125-APF28(40)



Key Features

Optics

- Day/night functionality
- Smart IR, up to 30m (98ft) IR distance
- 2D/3D DNR (Digital Noise Reduction)
- Built-in Mic

Compression

- Ultra 265, H.265, H.264, MJPEG
- ROI (Region of Interest)

Network

- ONVIF Conformance

Structure

- Wide temperature range: -30°C ~ 60°C (-22°F ~ 140°F)
- Wide voltage range of ±25%
- IP67
- 3-Axis

Dimensions

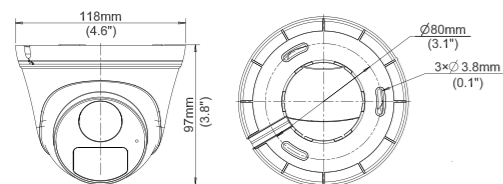

Specifications

	IPC-T125-APF28	IPC-T125-APF40
Camera		
Sensor	1/3", progressive scan, CMOS	
Lens	2.8mm@F2.1	
DORI Distance	Lens (mm)	4.0mm@F2.1
	Detect (m)	Observe (m)
Adjustment angle	2.8	25.2
	63.0	12.6
Shutter	4.0	36.0
	90.0	18.0
Minimum Illumination	Pan: 0° ~ 360°	
	Tilt: 0° ~ 80°	
Digital noise reduction	Rotate: 0° ~ 360°	
	Auto/Manual, 1 ~ 1/100000s	
Day/Night	Colour: 0.02Lux (F2.1, AGC ON)	
S/N	0Lux with IR on	
IR Range	2D/3D DNR	
Defog	IR-cut filter with auto switch (ICR)	
WDR	>56dB	
	Up to 30m (98ft) IR range	
	Digital Defog	
	DWDR	
	Ultra 265, H.265, H.264	
	Baseline profile, Main Profile, High profile	
	Main Stream: 5MP (2880*1620), Max 20fps;	
	4MP (2560*1440), Max 20fps; 3MP (2304*1296), Max 20fps;	
	1080P (1920*1080), Max 30fps;	
	Sub Stream: 720P (1280*720), Max 30fps; D1 (720*576), Max 30fps;	
	640*360, Max 30fps; 2CIF(704*288), Max 30fps;	
	CIF(352*288), Max 30fps;	
	Supported	
	Supported	
	Up to 4 OSDs	
	Up to 4 areas	
	Up to 8 areas	
	Up to 4 areas	
	IPV4, IGMP, ICMP, ARP, TCP, UDP, DHCP, RTP, RTSP, RTCP, DNS, DDNS, NTP, FTP, UPnP, HTTP, HTTPS, SMTP, SSL, QoS, RTMP	
	ONVIF (Profile S, Profile T), API	
	10/100M Base-TX Ethernet	
	Supported	
	DC 12V±25%, PoE	
	Ø 118 x 97mm (Ø4.6" x 3.8")	
	0.27kg (0.60lb)	
	-30°C ~ 60°C (-22°F ~ 140°F), Humidity: ≤95% RH (non-condensing)	
	IP67	

2MP HD VF Bullet Network Camera

IPC-B312-APKZ



Key Features

Optics

- Day/night functionality
- Smart IR, up to 50m (164ft) IR distance
- Optical glass window with higher light transmittance
- IR anti-reflection window to increase the infrared transmittance
- 2D/3D DNR (Digital Noise Reduction)
- Built-in Mic

Compression

- Ultra 265, H.265, H.264
- ROI (Region of Interest)

Network

- ONVIF Conformance

Structure

- Wide temperature range: -30°C ~ 60°C (-22°F ~ 140°F)
- Wide voltage range of ±25%
- IP67

Dimensions

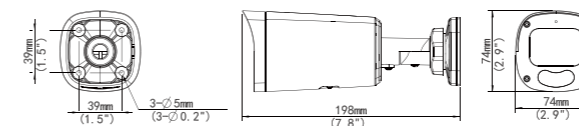

Specifications

	IPC-B312-APKZ				
Camera					
Sensor	1/2.7", progressive scan, CMOS				
Lens	2.8 ~ 12mm, AF automatic focusing and motorized zoom lens				
DORI Distance	Lens (mm)	Detect (m)	Observe (m)	Recognize (m)	Identify (m)
	2.8	42	16.8	8.4	4.2
Adjustment angle	12	180	72	36	18
	108.05° ~ 32.59°				
Angle of View (V)	56.81° ~ 18.36°				
Angle of View (O)	111.91° ~ 36.53°	Tilt: 0° ~ 90°		Rotate: 0° ~ 360°	
Shutter	Auto/Manual, 1 ~ 1/100000s				
Minimum Illumination	Colour: 0.01Lux (F1.8, AGC ON)				
Digital noise reduction	2D/3D DNR				
Day/Night	IR-cut filter with auto switch (ICR)				
S/N	>52dB				
IR Range	Up to 50m (164ft) IR range				
Defog	Digital Defog				
WDR	120dB				
Storage					
Edge Storage	Micro SD, up to 128GB				
Network Storage	ANR, NAS, NFS				
Video					
Video Compression	Ultra 265, H.265, H.264, MJPEG				
H.264 code profile	Baseline profile, Main Profile, High profile				
Frame Rate	Main Stream: 1080P (1920*1080), Max 30fps; 720P (1280*720), Max 30fps;				
	Sub Stream: 720P (1280*720), Max 30fps; D1 (720*576), Max 30fps;				
	640*360, Max 30fps; 2CIF(704*288), Max 30fps; CIF(352*288), Max 30fps;				
	Supported				
	Supported				
	Up to 4 OSDs				
	Up to 4 areas				
	Up to 8 areas				
	Up to 4 areas				
Smart					
Behavior Detection	Intrusion (based on human body detection)				
	Motion detection, tampering alarm, audio detection				
Network					
Protocols	IPV4, IGMP, ICMP, TCP, UDP, DHCP, RTP, RTSP, RTCP, DNS, DDNS, NTP, UPnP, HTTP, RTMP				
Compatible Integration	ONVIF (Profile S, Profile T, Profile G), API				
Interface					
Network	10/100M Base-TX Ethernet				
Built-in Mic	Supported				
General					
Power	DC 12V±25%, PoE				
Power consumption	Max 3.5W				
Ingress Protection	IP67				

2MP Vandal-resistant Network IR VF Dome Camera

IPC-D312-APKZ



Key Features

Optics

- Day/night functionality
- Smart IR, up to 30m (98ft) IR distance
- 2D/3D DNR (Digital Noise Reduction)
- Built-in Mic

Compression

- Ultra 265, H.265, H.264
- ROI (Region of Interest)

Network

- ONVIF Conformance

Structure

- Wide temperature range: -30°C ~ 60°C (-22°F ~ 140°F)
- Wide voltage range of ±25%
- IK10 vandal resistant
- IP67
- 3-Axis

Dimensions

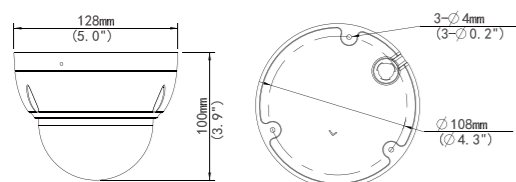

Specifications

IPC-D312-APKZ					
Camera					
Sensor	1/2.7", progressive scan, CMOS				
Lens	2.8 ~ 12mm, AF automatic focusing and motorized zoom lens				
DORI Distance	Lens (mm)	Detect (m)	Observe (m)	Recognize (m)	Identify (m)
	2.8	42	16.8	8.4	4.2
	12	180	72	36	18
Angle of View (H)	108.05°~ 32.59°				
Angle of View (V)	56.81°~ 18.36°				
Angle of View (O)	111.91°~36.53°				
Adjustment angle	Pan: 3° ~ 360°	Tilt: 0° ~ 70°	Rotate: 3° ~ 360°		
Shutter	Auto/Manual, 1 ~ 1/100000s				
Minimum Illumination	Colour: 0.01Lux (F1.8, AGC ON) 0Lux with IR on				
Digital noise reduction	2D/3D DNR				
Day/Night	IR-cut filter with auto switch (ICR)				
S/N	>52dB				
IR Range	Up to 30m (98ft) IR range				
Defog	Digital Defog				
WDR	120dB				
Storage					
Edge Storage	Micro SD, up to 128GB				
Network Storage	ANR,NAS(NFS)				
Video					
Video Compression	Ultra 265, H.265, H.264, MJPEG				
H.264 code profile	Baseline profile, Main Profile, High profile				
Frame Rate	Main Stream: 1080P (1920*1080), Max 30fps; 720P (1280*720), Max 30fps Sub Stream: 720P (1280*720), Max 30fps; D1 (720*576), Max 30fps; 640*360,Max 30fps; 2CIF(704*288), Max 30fps; CIF(352*288), Max 30fps;				
HLC	Supported				
BLC	Supported				
OSD	Up to 4 OSDs				
Privacy Mask	Up to 4 areas				
ROI	Up to 8 areas				
Motion Detection	Up to 4 areas				
Smart					
Behavior Detection	Intrusion(based on human body detection) Motion detection, tampering alarm, audio detection				
Network					
Protocols	IPv4, IGMP, ICMP, TCP, UDP, DHCP, RTP, RTSP, RTCP, DNS, DDNS, NTP, UPnP, HTTP, RTMP				
Compatible Integration	ONVIF (Profile S, Profile T, Profile G), API				
Interface					
Network	10/100M Base-TX Ethernet				
Built-in Mic	Supported				
General					
Power	DC 12V±25%, PoE Power consumption: Max 4.5W				
Ingress Protection	IP67				
Vandal Resistant	IK10				

2MP HD VF Turret Network Camera

IPC-T312-APKZ



Key Features

Optics

- Day/night functionality
- Smart IR, up to 30m (98ft) IR distance
- 2D/3D DNR (Digital Noise Reduction)
- Built-in Mic

Compression

- Ultra 265, H.265, H.264
- ROI (Region of Interest)

Network

- ONVIF Conformance

Structure

- Wide temperature range: -30°C ~ 60°C (-22°F ~ 140°F)
- Wide voltage range of ±25%
- IP67
- 3-Axis

Dimensions

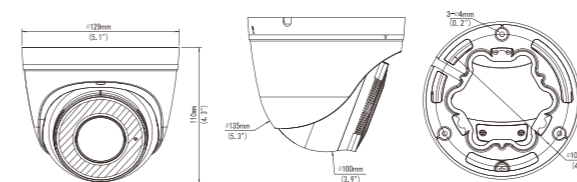

Specifications

IPC-T312-APKZ					
Camera					
Sensor	1/2.7", progressive scan, CMOS				
Lens	2.8 ~ 12mm, AF automatic focusing and motorized zoom lens				
DORI Distance	Lens (mm)	Detect (m)	Observe (m)	Recognize (m)	Identify (m)
	2.8	42	16.8	8.4	4.2
	12	180	72	36	18
Angle of View (H)	108.05°~ 32.59°				
Angle of View (V)	56.81°~ 18.36°				
Angle of View (O)	111.91°~36.53°				
Adjustment angle	Pan: 0° ~ 360°	Tilt: 0° ~ 75°	Rotate: 0° ~ 360°		
Shutter	Auto/Manual, 1 ~ 1/100000s				
Minimum Illumination	Colour: 0.01Lux (F1.8, AGC ON) 0Lux with IR on				
Digital noise reduction	2D/3D DNR				
Day/Night	IR-cut filter with auto switch (ICR)				
S/N	>52dB				
IR Range	Up to 30m (98ft) IR range				
Defog	Digital Defog				
WDR	120dB				
Storage					
Edge Storage	Micro SD, up to 128GB				
Network Storage	ANR,NAS(NFS)				
Video					
Video Compression	Ultra 265, H.265, H.264, MJPEG				
H.264 code profile	Baseline profile, Main Profile, High profile				
Frame Rate	Main Stream: 1080P (1920*1080), Max 30fps; 720P (1280*720), Max 30fps Sub Stream: 720P (1280*720), Max 30fps; D1 (720*576), Max 30fps; 640*360,Max 30fps; 2CIF(704*288), Max 30fps; CIF(352*288), Max 30fps;				
HLC	Supported				
BLC	Supported				
OSD	Up to 4 OSDs				
Privacy Mask	Up to 4 areas				
ROI	Up to 8 areas				
Motion Detection	Up to 4 areas				
Smart					
Behavior Detection	Intrusion(based on human body detection) Motion detection, tampering alarm, audio detection				
Network					
Protocols	IPv4, IGMP, ICMP, TCP, UDP, DHCP, RTP, RTSP, RTCP, DNS, DDNS, NTP, UPnP, HTTP, RTMP				
Compatible Integration	ONVIF (Profile S, Profile T, Profile G), API				
Interface					
Network	10/100M Base-TX Ethernet				
Built-in Mic	Supported				
General					
Power	DC 12V±25%, PoE Power consumption: Max 3.5W				
Ingress Protection	IP67				

4MP HD VF Bullet Network Camera

IPC-B314-APKZ



Key Features

Optics

- Day/night functionality
- Smart IR, up to 50m (164ft) IR distance
- Optical glass window with higher light transmittance
- IR anti-reflection window to increase the infrared transmittance
- 2D/3D DNR (Digital Noise Reduction)
- Built-in Mic

Compression

- Ultra 265, H.265, H.264, MJPEG
- ROI (Region of Interest)

Network

- ONVIF Conformance

Structure

- Wide temperature range: -30°C ~ 60°C (-22°F ~ 140°F)
- Wide voltage range of ±25%
- IP67

Dimensions

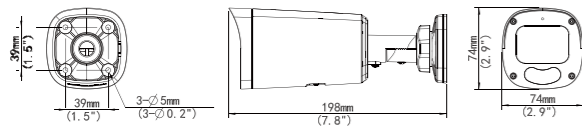

Specifications

IPC-B314-APKZ					
Camera					
Sensor	1/2.7", progressive scan, CMOS				
Lens	2.8 ~ 12mm, AF automatic focusing and motorized zoom lens				
DORI Distance	Lens (mm)	Detect (m)	Observe (m)	Recognize (m)	Identify (m)
	2.8	63.0	25.2	12.6	6.3
	12	270.0	108.0	54.0	27.0
Angle of View (H)	102.79°~ 30.86°				
Angle of View (V)	54.50°~ 17.49°				
Angle of View (O)	106.94°~35.49°				
Adjustment angle	Pan: 0° ~ 360°	Tilt: 0° ~ 90°	Rotate: 0° ~ 360°		
Shutter	Auto/Manual, 1 ~ 1/100000s				
Minimum Illumination	Colour: 0.005Lux (F1.8, AGC ON) 0Lux with IR on				
Digital noise reduction	2D/3D DNR				
Day/Night	IR-cut filter with auto switch (ICR)				
S/N	>56dB				
IR Range	Up to 50m (164ft) IR range				
Defog	Digital Defog				
WDR	120dB				
Storage					
Edge Storage	Micro SD, up to 256GB				
Network Storage	ANR, NAS(NFS)				
Video					
Video Compression	Ultra 265, H.265, H.264, MJPEG				
H.264 code profile	Baseline profile, Main profile, High profile				
Frame Rate	Main Stream: 4MP (2560*1440), Max 25fps; 3MP (2304*1296), Max 30fps; 1080P (1920*1080), Max 30fps; Sub Stream: 720P (1280*720), Max 30fps; D1 (720*576), Max 30fps; 640*360, Max 30fps; 2CIF(704*288), Max 30fps; CIF(352*288), Max 30fps;				
HLC	Supported				
BLC	Supported				
OSD	Up to 4 OSDs				
Privacy Mask	Up to 4 areas				
ROI	Up to 8 areas				
Motion Detection	Up to 4 areas				
Smart					
Behavior Detection	Intrusion(based on human body detection) Motion detection, tampering alarm, audio detection				
Network					
Protocols	IPv4, IGMP, ICMP, ARP, TCP, UDP, DHCP, RTP, RTSP, RTCP, DNS, DDNS, NTP, FTP, UPnP, HTTP, HTTPS, SMTP, SSL, QoS, RTMP				
Compatible Integration	ONVIF (Profile S, Profile T, Profile G), API				
Interface					
Network	10/100M Base-TX Ethernet				
Built-in Mic	Supported				
General					
Power	DC 12V±25%, PoE Power consumption: Max 7.5W				
Ingress Protection	IP67				

4MP Vandal-resistant Network IR VF Dome Camera

IPC-D314-APKZ



Key Features

Optics

- Day/night functionality
- Smart IR, up to 30m (98ft) IR distance
- 2D/3D DNR (Digital Noise Reduction)
- Built-in Mic

Compression

- Ultra 265, H.265, H.264, MJPEG
- ROI (Region of Interest)

Network

- ONVIF Conformance

Structure

- Wide temperature range: -30°C ~ 60°C (-22°F ~ 140°F)
- Wide voltage range of ±25%
- IK10 vandal resistant
- IP67
- 3-Axis

Dimensions

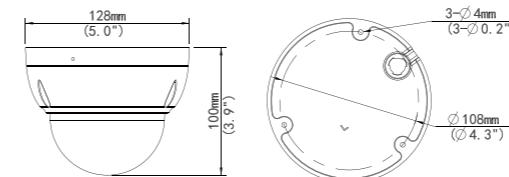

Specifications

IPC-D314-APKZ					
Camera					
Sensor	1/2.7", progressive scan, CMOS				
Lens	2.8 ~ 12mm, AF automatic focusing and motorized zoom lens				
DORI Distance	Lens (mm)	Detect (m)	Observe (m)	Recognize (m)	Identify (m)
	2.8	63.0	25.2	12.6	6.3
	12	270.0	108.0	54.0	27.0
Angle of View (H)	102.79°~ 30.86°				
Angle of View (V)	54.50°~ 17.49°				
Angle of View (O)	106.94°~35.49°				
Adjustment angle	Pan: 3° ~ 360°	Tilt: 0° ~ 70°	Rotate: 3° ~ 360°		
Shutter	Auto/Manual, 1 ~ 1/100000s				
Minimum Illumination	Colour: 0.005Lux (F1.8, AGC ON) 0Lux with IR on				
Digital noise reduction	2D/3D DNR				
Day/Night	IR-cut filter with auto switch (ICR)				
S/N	>56dB				
IR Range	Up to 30m (98ft) IR range				
Defog	Digital Defog				
WDR	120dB				
Storage					
Edge Storage	Micro SD, up to 256GB				
Network Storage	ANR, NAS(NFS)				
Video					
Video Compression	Ultra 265, H.265, H.264, MJPEG				
H.264 code profile	Baseline profile, Main Profile				
Frame Rate	Main Stream: 4MP (2560*1440), Max 25fps; 3MP (2304*1296), Max 30fps; 1080P (1920*1080), Max 30fps; Sub Stream: 720P (1280*720), Max 30fps; D1 (720*576), Max 30fps; 640*360, Max 30fps; 2CIF(704*288), Max 30fps; CIF(352*288), Max 30fps;				
HLC	Supported				
BLC	Supported				
OSD	Up to 4 OSDs				
Privacy Mask	Up to 4 areas				
ROI	Up to 8 areas				
Motion Detection	Up to 4 areas				
Smart					
Behavior Detection	Intrusion(based on human body detection) Motion detection, tampering alarm, audio detection				
Network					
Protocols	IPv4, IGMP, ICMP, ARP, TCP, UDP, DHCP, RTP, RTSP, RTCP, DNS, DDNS, NTP, FTP, UPnP, HTTP, HTTPS, SMTP, SSL, QoS, RTMP				
Compatible Integration	ONVIF (Profile S, Profile T, Profile G), API				
Interface					
Network	10/100M Base-TX Ethernet				
Built-in Mic	Supported				
General					
Power	DC 12V±25%, PoE Power consumption: Max 4.5W				
Ingress Protection	IP67				
Vandal Resistant	IK10				

4MP HD VF Turret Network Camera

IPC-T314-APKZ



Key Features

Optics

- Day/night functionality
- Smart IR, up to 30m (98ft) IR distance
- 2D/3D DNR (Digital Noise Reduction)
- Built-in Mic

Compression

- Ultra 265, H.265, H.264, MJPEG
- ROI (Region of Interest)

Network

- ONVIF Conformance

Structure

- Wide temperature range: -30°C ~ 60°C (-22°F ~ 140°F)
- Wide voltage range of ±25%
- IP67
- 3-Axis

Dimensions

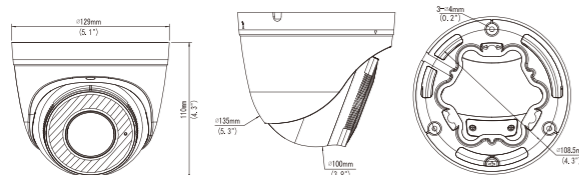

Specifications

IPC-T314-APKZ	
Camera	
Sensor	1/3", progressive scan, CMOS
Lens	2.8 ~ 12mm, AF automatic focusing and motorized zoom lens
DORI Distance	Lens (mm) Detect (m) Observe (m) Recognize (m) Identify (m)
	2.8 63.0 25.2 12.6 6.3
	12 270.0 108.0 54.0 27.0
Angle of View (H)	102.79°~ 30.86°
Angle of View (V)	54.50°~ 17.49°
Angle of View (O)	106.94°~35.49°
Adjustment angle	Pan: 0° ~ 360° Tilt: 0° ~ 75° Rotate: 0° ~ 360°
Shutter	Auto/Manual, 1 ~ 1/100000s
Minimum Illumination	Colour: 0.005Lux (F1.8, AGC ON) 0Lux with IR on
Digital noise reduction	2D/3D DNR
Day/Night	IR-cut filter with auto switch (ICR)
S/N	>56dB
IR Range	Up to 30m (98ft) IR range
Defog	Digital Defog
WDR	120dB
Storage	
Edge Storage	Micro SD, up to 256GB
Network Storage	ANR, NAS(NFS)
Video	
Video Compression	Ultra 265, H.265, H.264, MJPEG
H.264 code profile	Baseline profile, Main profile, High profile
Frame Rate	Main Stream: 4MP (2560*1440), Max 25fps; 3MP (2304*1296), Max 30fps; 1080P (1920*1080), Max 30fps; Sub Stream: 720P (1280*720), Max 30fps; D1 (720*576), Max 30fps; 640*360, Max 30fps; 2CIF(704*288), Max 30fps; CIF(352*288), Max 30fps;
HLC	Supported
BLC	Supported
OSD	Up to 4 OSDs
Privacy Mask	Up to 4 areas
ROI	Up to 8 areas
Motion Detection	Up to 4 areas
Smart	
Behavior Detection	Intrusion(based on human body detection) Motion detection, tampering alarm, audio detection
Network	
Protocols	IPv4, IGMP, ICMP, ARP, TCP, UDP, DHCP, RTP, RTSP, RTCP, DNS, DDNS, NTP, FTP, UPnP, HTTP, HTTPS, SMTP, SSL, QoS, RTMP
Compatible Integration	ONVIF (Profile S, Profile T), API
Interface	
Network	10/100M Base-TX Ethernet
Built-in Mic	Supported
General	
Power	DC 12V±25%, PoE Power consumption: Max 6.0W
Ingress Protection	IP67

5MP HD VF Bullet Network Camera

IPC-B315-APKZ



Key Features

Optics

- Day/night functionality
- Smart IR, up to 50m (164ft) IR distance
- Optical glass window with higher light transmittance
- IR anti-reflection window to increase the infrared transmittance
- 2D/3D DNR (Digital Noise Reduction)
- Built-in Mic

Compression

- Ultra 265, H.265, H.264, MJPEG
- ROI (Region of Interest)

Network

- ONVIF Conformance

Structure

- Wide temperature range: -30°C ~ 60°C (-22°F ~ 140°F)
- Wide voltage range of ±25%
- IP67

Dimensions

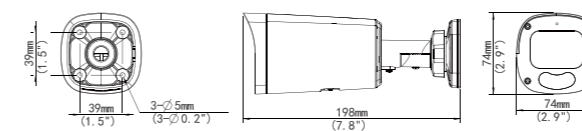

Specifications

IPC-B315-APKZ	
Camera	
Sensor	1/3", progressive scan, CMOS
Lens	2.8 ~ 12mm, AF automatic focusing and motorized zoom lens
DORI Distance	Lens (mm) Detect (m) Observe (m) Recognize (m) Identify (m)
	2.8 63.0 25.2 12.6 6.3
	12 270.0 108.0 54.0 27.0
Angle of View (H)	102.79°~ 30.86°
Angle of View (V)	54.50°~ 17.49°
Angle of View (O)	106.94°~35.49°
Adjustment angle	Pan: 0° ~ 360° Tilt: 0° ~ 90° Rotate: 0° ~ 360°
Shutter	Auto/Manual, 1 ~ 1/100000s
Minimum Illumination	Colour: 0.005Lux (F1.8, AGC ON) 0Lux with IR on
Digital noise reduction	2D/3D DNR
Day/Night	IR-cut filter with auto switch (ICR)
S/N	>56dB
IR Range	Up to 50m (164ft) IR range
Defog	Digital Defog
WDR	120dB
Storage	
Edge Storage	Micro SD, up to 256GB
Network Storage	ANR, NAS(NFS)
Video	
Video Compression	Ultra 265, H.265, H.264, MJPEG
H.264 code profile	Baseline profile, Main profile, High profile
Frame Rate	Main Stream: 5MP (2880*1620), Max 25fps; 4MP (2560*1440), Max 25fps; 3MP (2304*1296), Max 30fps; 1080P (1920*1080), Max 30fps; Sub Stream: 720P (1280*720), Max 30fps; D1 (720*576), Max 30fps; 640*360, Max 30fps; 2CIF(704*288), Max 30fps; CIF(352*288), Max 30fps;
HLC	Supported
BLC	Supported
OSD	Up to 4 OSDs
Privacy Mask	Up to 4 areas
ROI	Up to 8 areas
Motion Detection	Up to 4 areas
Smart	
Behavior Detection	Intrusion(based on human body detection) Motion detection, tampering alarm, audio detection
Network	
Protocols	IPv4, IGMP, ICMP, ARP, TCP, UDP, DHCP, RTP, RTSP, RTCP, DNS, DDNS, NTP, FTP, UPnP, HTTP, HTTPS, SMTP, SSL, QoS, RTMP
Compatible Integration	ONVIF (Profile S, Profile T, Profile G), API
Interface	
Network	10/100M Base-TX Ethernet
Built-in Mic	Supported
General	
Power	DC 12V±25%, PoE Power consumption: Max 7.5W
Ingress Protection	IP67

5MP Vandal-resistant Network IR VF Dome Camera

IPC-D315-APKZ



Key Features

Optics

- Day/night functionality
- Smart IR, up to 30m (98ft) IR distance
- 2D/3D DNR (Digital Noise Reduction)
- Built-in Mic

Compression

- Ultra 265, H.265, H.264, MJPEG
- ROI (Region of Interest)

Network

- ONVIF Conformance

Structure

- Wide temperature range: -30°C ~ 60°C (-22°F ~ 140°F)
- Wide voltage range of ±25%
- IK10 vandal resistant
- IP67
- 3-Axis

Dimensions

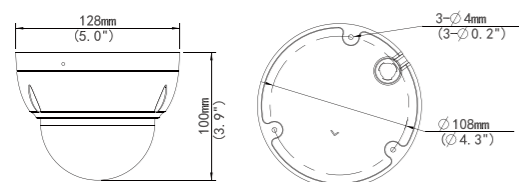

Specifications

IPC-D315-APKZ	
Camera	
Sensor	1/2.7", progressive scan, CMOS
Lens	2.8 ~ 12mm, AF automatic focusing and motorized zoom lens
DORI Distance	Lens (mm) Detect (m) Observe (m) Recognize (m) Identify (m)
	2.8 63.0 25.2 12.6 6.3
	12 270.0 108.0 54.0 27.0
Angle of View (H)	102.79°~ 30.86°
Angle of View (V)	54.50°~ 17.49°
Angle of View (O)	106.94°~35.49°
Adjustment angle	Pan: 3° ~ 360° Tilt: 0° ~ 70° Rotate: 3° ~ 360°
Shutter	Auto/Manual, 1 ~ 1/100000s
Minimum Illumination	Colour: 0.005Lux (F1.8, AGC ON) 0Lux with IR on
Digital noise reduction	2D/3D DNR
Day/Night	IR-cut filter with auto switch (ICR)
S/N	>56dB
IR Range	Up to 30m (98ft) IR range
Defog	Digital Defog
WDR	120dB
Storage	
Edge Storage	Micro SD, up to 256GB
Network Storage	ANR, NAS(NFS)
Video	
Video Compression	Ultra 265, H.265, H.264, MJPEG
H.264 code profile	Baseline profile, Main profile, High profile
Frame Rate	Main Stream: 5MP (2880*1620), Max 25fps; 4MP (2560*1440), Max 25fps; 3MP (2304*1296), Max 30fps; 1080P (1920*1080), Max 30fps; Sub Stream: 720P (1280*720), Max 30fps; D1 (720*576), Max 30fps; 640*360, Max 30fps; 2CIF(704*288), Max 30fps; CIF(352*288), Max 30fps;
HLC	Supported
BLC	Supported
OSD	Up to 4 OSDs
Privacy Mask	Up to 4 areas
ROI	Up to 8 areas
Motion Detection	Up to 4 areas
Smart	
Behavior Detection	Intrusion(based on human body detection) Motion detection, tampering alarm, audio detection
Network	
Protocols	IPv4, IGMP, ICMP, ARP, TCP, UDP, DHCP, RTP, RTSP, RTCP, DNS, DDNS, NTP, FTP, UPnP, HTTP, HTTPS, SMTP, SSL, QoS, RTMP
Compatible Integration	ONVIF (Profile S, Profile T, Profile G), API
Interface	
Network	10/100M Base-TX Ethernet
Built-in Mic	Supported
General	
Power	DC 12V±25%, PoE Power consumption: Max 6.0W
Ingress Protection	IP67
Vandal Resistant	IK10

5MP HD VF Turret Network Camera

IPC-T315-APKZ



Key Features

Optics

- Day/night functionality
- Smart IR, up to 30m (98ft) IR distance
- 2D/3D DNR (Digital Noise Reduction)
- Built-in Mic

Compression

- Ultra 265, H.265, H.264, MJPEG
- ROI (Region of Interest)

Network

- ONVIF Conformance

Structure

- Wide temperature range: -30°C ~ 60°C (-22°F ~ 140°F)
- Wide voltage range of ±25%
- IP67
- 3-Axis

Dimensions

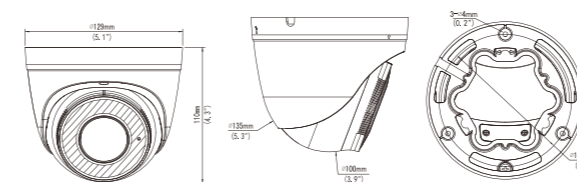

Specifications

IPC-T315-APKZ	
Camera	
Sensor	1/2.7", progressive scan, CMOS
Lens	2.8 ~ 12mm, AF automatic focusing and motorized zoom lens
DORI Distance	Lens (mm) Detect (m) Observe (m) Recognize (m) Identify (m)
	2.8 63.0 25.2 12.6 6.3
	12 270.0 108.0 54.0 27.0
Angle of View (H)	102.79°~ 30.86°
Angle of View (V)	54.50°~ 17.49°
Angle of View (O)	106.94°~35.49°
Adjustment angle	Pan: 0° ~ 360° Tilt: 0° ~ 75° Rotate: 0° ~ 360°
Shutter	Auto/Manual, 1 ~ 1/100000s
Minimum Illumination	Colour: 0.005Lux (F1.8, AGC ON) 0Lux with IR on
Digital noise reduction	2D/3D DNR
Day/Night	IR-cut filter with auto switch (ICR)
S/N	>56dB
IR Range	Up to 30m (98ft) IR range
Defog	Digital Defog
WDR	120dB
Storage	
Edge Storage	Micro SD, up to 256GB
Network Storage	ANR, NAS(NFS)
Video	
Video Compression	Ultra 265, H.265, H.264, MJPEG
H.264 code profile	Baseline profile, Main profile, High profile
Frame Rate	Main Stream: 5MP (2880*1620), Max 25fps; 4MP (2560*1440), Max 25fps; 3MP (2304*1296), Max 30fps; 1080P (1920*1080), Max 30fps; Sub Stream: 720P (1280*720), Max 30fps; D1 (720*576), Max 30fps; 640*360, Max 30fps; 2CIF(704*288), Max 30fps; CIF(352*288), Max 30fps;
HLC	Supported
BLC	Supported
OSD	Up to 4 OSDs
Privacy Mask	Up to 4 areas
ROI	Up to 8 areas
Motion Detection	Up to 4 areas
Smart	
Behavior Detection	Intrusion(based on human body detection) Motion detection, tampering alarm, audio detection
Network	
Protocols	IPv4, IGMP, ICMP, ARP, TCP, UDP, DHCP, RTP, RTSP, RTCP, DNS, DDNS, NTP, FTP, UPnP, HTTP, HTTPS, SMTP, SSL, QoS, RTMP
Compatible Integration	ONVIF (Profile S, Profile T, Profile G), API
Interface	
Network	10/100M Base-TX Ethernet
Built-in Mic	Supported
General	
Power	DC 12V±25%, PoE Power consumption: Max 6.0W
Ingress Protection	IP67

3MP HD Fixed Dual-light Bullet Network Camera

IPC-B213-APF40W



Key Features

Optics

- Day/night functionality
- Smart IR, up to 50m (164ft) IR distance
- Optical glass window with higher light transmittance
- IR anti-reflection window to increase the infrared transmittance
- 2D/3D DNR (Digital Noise Reduction)
- Built-in Mic

Compression

- Ultra 265, H.265, H.264
- ROI (Region of Interest)

Network

- ONVIF Conformance

Structure

- Wide temperature range: -30°C ~ 60°C (-22°F ~ 140°F)
- Wide voltage range of ±25%
- IP67

Dimensions

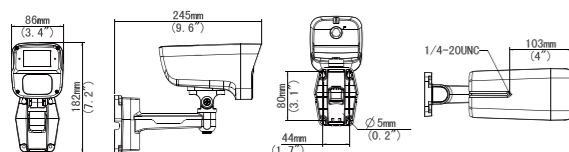

Specifications

IPC-B213-APF40W	
Image	
Sensor	1/2.8", progressive scan, CMOS
Minimum Illumination	Colour: 0.01Lux (F2.0, AGC ON) 0Lux with IR on
WDR	DWDR
Lens	
Lens Type	4.0mm @2.0, Fixed-focal
Angle of View (H)	89.0°
Angle of View (V)	46.9°
Angle of View (O)	93.8°
Illuminator	
IR Range	Up to 50m (164ft) IR range
White Light Range	Up to 30m (98ft) White light range
Video	
Video Compression	Ultra 265, H.265, H.264
H.264 code profile	Baseline profile, Main profile, High profile
Frame Rate	Main Stream: 3MP (2304*1296), Max 25fps; 1080P (1920*1080), Max 30fps; 720P (1280*720), Max 30fps; Sub Stream: 4CIF (704*576), Max 30fps; 640*360, Max 30fps; 2CIF (704*288), Max 30fps; CIF (352*288), Max 30fps;
Image	
White Balance	Auto/Outdoor/Fine Tune/Sodium Lamp/Locked/Auto2
Digital Noise Reduction	2D/3D DNR
Smart IR	Supported
HLC	Supported
BLC	Supported
Defog	Digital Defog
Events	
Basic Detection	motion detection, human body detection, audio detection
General Function	Watermark, IP address filtering, access policy, ARP protection, RTSP authentication, user authentication, HTTP authentication
Network	
Protocols	IPv4, IGMP, ICMP, TCP, UDP, DHCP, RTP, RTSP, RTCP, DNS, DDNS, NTP, UPnP, HTTP, RTMP
Compatible Integration	ONVIF (Profile S, Profile T), API
Client	Uniarch Client Uniarch APP
Interface	
Network	1 * RJ45 10M/100M Base-TX Ethernet
Built-in Mic	Supported
General	
Ingress Protection	Ingress protection: IP67

3MP 20X Network PTZ Camera

IPC-P413-X20



Key Features

- High quality image with 4MP, 1/2.8" CMOS sensor
- 2688*1520@30fps in the main stream
- Ultra 265, H.265, H.264, MJPEG
- Triple streams
- 25X Optical Zoom
- Smart intrusion prevention, support false alarm filtering, include Cross Line, Intrusion, Enter Area, Leave Area detection
- Lighthunter technology ensures ultra-high image quality in low illumination environment
- Smart IR, up to 100m (328ft) IR distance
- DC 12V±25% or PoE+ (IEEE 802.3at)
- Alarm 2 in and 1 out, Audio 1 in and 1 out
- IP67 ingress protection
- IK10 vandal resistant

Accessories



Specifications

IPC-P413-X20	
Camera	
Sensor	1/2.8", 3.0 megapixel, progressive scan, CMOS
Lens type	5 ~ 100mm, AF automatic focusing and motorized zoom lens, Fixed; F1.7 ~ F2.8
Optical Zoom	20
Angle of View (H)	51.70° ~ 3.85°
Angle of View (V)	30.49° ~ 2.16°
Angle of View (O)	63.60° ~ 4.54°
DORI Distance	Lens (mm) Detect (m) Observe (m) Recognize (m) Identify (m)
	5 90.0 (295.3ft) 36.0 (118.1ft) 18.0 (59.1ft) 9.0 (29.5ft)
100 1272.4 (4174.6ft) 509.0 (1669.8ft) 254.5 (834.9ft) 127.2 (417.5ft)	
IR Range	Up to 100m (328 ft) IR range
Video	
Video Compression	H.265, H.264, MJPEG
Frame Rate	Main Stream: 3MP (2304*1296), Max 30fps; Sub Stream: 720P (1280*720), Max 30fps; Third Stream: D1 (720*576), Max 30fps;
ROI	Support
OSD	Up to 8 OSDs
Privacy Mask	24 areas, up to 4 areas per scene
White Balance	Auto/Outdoor/Fine Tune/Sodium Lamp/Locked/Auto2
HLC	Support
BLC	Support
Defog	Digital Defog
Smart	
Smart Intrusion Prevention	Support false alarm filtering: Cross Line detection, Intrusion detection
Face Capture	Support, Face attributes: Gender, Age range, Glasses, Mask
People Counting	Support people flow counting and crowd density monitoring
Basic Detection	Motion detection, Tampering Alarm
Auto Tracking	Support
Storage	
Edge Storage	Micro SD, up to 256 GB
Pan & Tilt	
Pan Range	360° (endless)
Tilt Range	-15° ~ 90° (auto reverse)
Pan Speed	0.1°/s ~ 80°/s
Pan Speed	0.1°/s ~ 80°/s
Pan Speed	Preset speed: 80°/s
Tilt Speed	Preset speed: 80°/s
Number of Presets	1024
Home Position	Support
Interface	
Network	1 * RJ45 10M/100M Base-TX Ethernet
General	
Power	DC12V (±25%), PoE+(IEEE 802.3at)
Power	Power consumption: MAX 20W
Protection	Ingress protection: IP66 (IEC 60529:1989+AMD1:1999+AMD2:2013)

3MP HD Dual-light Network PT Camera

IPC-P213-AF40KC



Key Features

- 2304*1296@20fps in the main stream
- Ultra 265, H.265, H.264
- Smart intrusion prevention, support false alarm filtering, include cross line detection and intrusion detection
- Support digital WDR (Wide Dynamic Range)
- Built-in Mic & Speaker, support two-way audio, offer better interaction
- Smart IR, Up to 30 m (98 ft) IR and 30m (98 ft) warm light distance, suitable for more scenes
- Self-contained bracket, support two kinds of mounting
- Supports 256 G Micro SD card
- IP66 ingress protection
- DC12V or PoE (IEEE 802.3af) power supply
- The front face is made of grapheme, which has better heat dissipation and more environmental protection

Dimensions

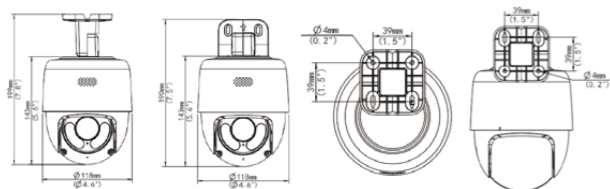

Specifications

IPC-P213-AF40KC					
Camera					
Sensor	1/2.8" progressive scan, 3.0 megapixel, CMOS				
Lens type	4mm, Fixed; F1.6				
Field of View (H)	90.5°	Field of View (V)	44.4°	Field of View (D)	111.3°
DORI Distance	Lens (mm)	Detect (m)	Observe (m)	Recognize (m)	Identify (m)
	Up to 30m (98ft)	73.5 (241.0ft)	29.4 (96.4ft)	14.7 (48.2ft)	7.3 (24.1ft)
IR Range	Up to 30m (98ft)				
Warm Light Range	Up to 30m (98ft)				
Wavelength	850nm				
IR On/Off Control	Auto/Manual				
Video					
Video Compression	Ultra 265, H.265, H.264				
Frame Rate	Main Stream: 3MP (2304*1296), Max 20fps; Sub Stream: D1 (720*576), Max 20fps;				
ROI	Support				
OSD	Up to 2 OSDs				
Privacy Mask	24 areas, up to 4 areas per scene				
White Balance	Auto/Outdoor/Fine Tune/Sodium Lamp/Locked/Auto2				
HLC	Support				
BLC	Support				
Defog	Digital Defog				
Smart					
Smart Intrusion Prevention	Support false alarm filtering: Cross Line detection, Intrusion detection				
Basic Detection	Motion detection, Audio detection				
Storage					
Edge Storage	Micro SD, up to 256 GB				
Pan & Tilt					
Pan Range	0° ~ 345°	Tilt Range	0° ~ 90°		
Pan Speed	1°/s ~ 40°/s	Tilt Speed	0.1°/s ~ 30°/s		
	Preset speed: 40°/s		Preset speed: 30°/s		
Number of Presets	256				
Home Position	Support				
Interface					
Built-in Mic	Support				
Built-in Speaker	Support				
Network	1 * RJ45 10M/100M Base-TX Ethernet				
General					
Power	DC 12V±25%, PoE(IEEE 802.3af)				
	Power consumption: TBD				
Protection	Ingress protection: IP66				

2MP Smart Pan & Tilt Camera

Uho-S1



Key Features

- Easy to install and use.
- Clear and smooth video browsing; intelligent transmission
- giving full play to capabilities of the network.
- Online firmware upgrade, and synchronous updating of the functions and experience.
- Two-way audio supported.
- Remote real-time monitoring supported with Android and iOS smart phones.
- IR light for night vision; 24h round-the-clock monitoring.
- Intelligent push to filter out useless information.
- QR code intelligent connection.
- Supporting human detection, pet snapshot and activity zone.*

Dimensions

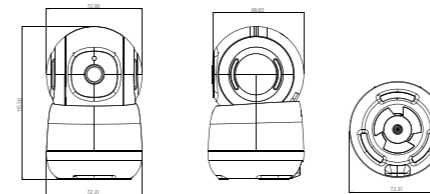

Specifications

Uho-S1	
Camera	
Sensor	1/3" color CMOS sensor, 2.0 megapixel.
Lens	3.6mm@F2.0
Angle of View	H (horizontal) 85°; V (vertical) 48°; D (diagonal) 100°.
Minimum Illumination	0.01Lux
IR Range	Up to 7m IR range
Audio	
Input / Output	Two-way audio available (built-in microphone and speaker).
Video	
Video Compression	H.264/H.265
Lighting frequency	50Hz, 60Hz
Image	FHD:1920*1080@15fps/10fps(IR mode) SD:640*360@15fps/10fps(IR mode)
Network	
Protocols	TCP/IP, UDP/IP
Wireless Network	2.4G Wi-Fi (IEEE802.11b/g/n), built-in antenna.
IP Address	DHCP
Interface	
Power Supply	1 Micro USB interface, DC 5V/1A
SD card	1 Micro SD card slot
Keys	1 Reset key
Storage	
Cloud storage	Supported*
SD card storage	Supported (up to 128 GB)
Intelligent functions	
Motion detection	Supported
Motion tracking	Supported
Intelligent push	Supported*
Pet detection	Supported*
Human detection	Supported*
Alarm	
Alarm linkage	Support video recording, sound alarm.
Alarm notification	Alarm push by mobile APP.
General	
Mount method	Ceiling or wall mounted
Dimensions (L x W x H)	72.3 x 72.3 x 115.5mm
Weight	180g
Working Environment	-10°C ~ 45°C /10% ~ 80% (no condensation)
Storage Environment	-20°C ~ 60°C /0% ~ 90% (no condensation)
Pan and Tilt	H (horizontal) 0° ~ 355°; V (vertical) -20° ~ 90°
LED indication	Monochrome white light

2MP Smart PT Camera

Uho-S2E



Overview

Uho-S2E is a 2MP indoor PT camera with real-time two-way audio, HD night vision, motion detection, audio detection and other functions. The pan&tilt design allows the camera to flexibly rotate horizontally and vertically, realizing 355° pan range. Used with Uniarch APP and EZCloud, you can check the real-time indoor situation anytime and anywhere.

Features

- 2MP, IR night vision.
- 355° wide pan range.
- Two-way audio, 24-hour guard.
- Multiple detection ways.
- Easy and convenient to use.

Dimensions

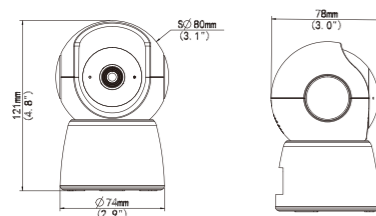

Specifications

Uho-S2E	
Image	
Image sensor	2MP, 1/3" CMOS sensor
Lens	4mm@F2.0
FOV	H (horizontal) 86°; V (vertical) 46°; D (diagonal) 104°
Min. illumination	0.01Lux
Illumination range	IR 10m
Audio	
Input/output	Two-way audio (built-in Mic and speaker)
Pickup range	5m
Audio compression	G711A
Video	
Video compression	H.264/H.265
Video bit rate	Averages≤1536 Kbps, maximum≤1920 Kbps
Network	
Protocol	TCP/IP
Interface	RJ45*1
Wi-Fi	2.4G Wi-Fi (IEEE802.11b/g/n), built-in antenna
IPv6	Supported
Compatible Integration	ONVIF (Profile S, Profile G, Profile T), API
Interface	
Power	Micro USB interface, DC 5V/1A
SD card	Micro SD card slot
Button	Reset button
Storage	
SD card storage	Supported (up to 256 GB)
NVR storage	Networking with NVR, video can be stored in NVR
Detection function	
Motion detection	Supported
Motion tracking	Supported
Audio detection	Supported
Human body detection	Supported
General	
Mount method	Wall/pendant/desktop mount
Weight	About 173g
Operating environment	Operating temperature:-10°C to 55°C; operating humidity: < 95%, non-condensing
Pan/tilt range	Pan 355°, tilt 105°
LED indicator	1, red/blue

2MP Smart PT Camera

Uho-S2



Overview

Uho-S2 is a 2MP indoor PT camera with real-time two-way audio, HD night vision, motion detection, audio detection and other functions. The pan&tilt design allows the camera to flexibly rotate horizontally and vertically, realizing 355° pan range. Used with Uniarch APP and EZCloud, you can check the real-time indoor situation anytime and anywhere.

Features

- 2MP, IR night vision.
- 355° wide pan range.
- Two-way audio, 24-hour guard.
- Multiple detection ways.
- Easy and convenient to use.

Dimensions

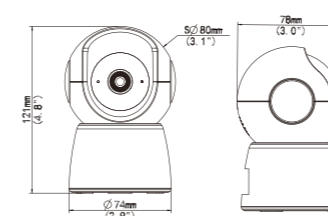

Specifications

Uho-S2	
Image	
Image sensor	2MP, 1/3" CMOS sensor
Lens	4mm@F2.0
FOV	H (horizontal) 86°; V (vertical) 46°; D (diagonal) 104°
Min. illumination	0.01Lux
Illumination range	IR 10m
Audio	
Input/output	Two-way audio (built-in Mic and speaker)
Pickup range	5m
Audio compression	G711A
Video	
Video compression	H.264/H.265
Video bit rate	Averages≤1536 Kbps, maximum≤1920 Kbps
Network	
Wi-Fi	2.4G Wi-Fi (IEEE802.11b/g/n), built-in antenna
Compatible Integration	ONVIF (Profile S, Profile G, Profile T), API
Interface	
Power	Micro USB interface, DC 5V/1A
SD card	Micro SD card slot
Button	Reset button
Storage	
SD card storage	Supported (up to 256 GB)
NVR storage	Networking with NVR, video can be stored in NVR
Detection function	
Motion detection	Supported
Motion tracking	Supported
Audio detection	Supported
Human body detection	Supported
General	
Mount method	Wall/pendant/desktop mount
Weight	About 173g
Operating environment	Operating temperature:-10°C to 55°C; operating humidity: < 95%, non-condensing
Pan/tilt range	Pan 355°, tilt 105°
LED indicator	1, red/blue

NVR-104LS-P4



Key Features

- Support Ultra 265/H.265/H.264 video formats
- 4-channel input
- Plug & Play with 4 independent PoE network interfaces
- Third-party IP cameras supported with ONVIF conformance: Profile S, Profile G, Profile T
- Support 1-ch HDMI, 1-ch VGA
- HDMI and VGA simultaneous output
- Up to 5MP resolution recording
- 1 SATA HDD, up to 10 TB
- Support cloud upgrad

Dimensions

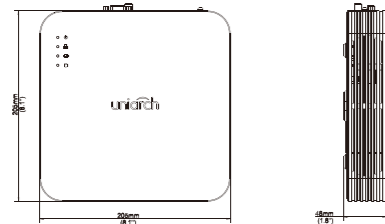

Rear Panel

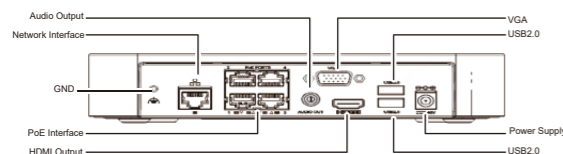

Specifications

Model	NVR-104LS-P4
Video/Audio Input	
IP Video Input	4-ch
Network	
Incoming Bandwidth	40Mbps
Outgoing Bandwidth	40Mbps
Remote Users	128
Protocols	P2P, NTP, DHCP, PPPoE
Video/Audio Output	
HDMI/VGA Output	HDMI: 1920x1080p/60Hz, 1920x1080p/50Hz, 1600x1200/60Hz, 1280x1024/60Hz, 1280x720/60Hz, 1024x768/60Hz VGA: 1920x1080p/60Hz, 1920x1080p/50Hz, 1600x1200/60Hz, 1280x1024/60Hz, 1280x720/60Hz, 1024x768/60Hz
Audio Output	1 RCA
Recording Resolution	1080p/960p/720p/D1/2CIF/CIF
Synchronous Playback	4-ch
Decoding	
Decoding format	Ultra 265/H.265/H.264
Liveview/Playback	1080p/960p/720p/D1/2CIF/CIF
Capability	1 x5MP@30, 2 x4MP@25, 2 x3MP@30, 4 x 1080p@25
Hard Disk	
SATA	1 SATA interface
Capacity	up to 10TB for each disk
External Interface	
Network Interface	1 RJ45 10M/100M self-adaptive Ethernet Interface
USB Interface	Rear panel: 2 x USB2.0
PoE	
Interface	4 independent 100 Mbps PoE network interfaces
Max Power	Max 30W for single port Max 54W in total (13.5W for each)
Supported Standard	IEEE 802.3at, IEEE 802.3af
General	
Power Supply	48V DC Power Consumption: ≤10 W (without HDD)
Working Environment	-10°C ~ +55°C (+14°F ~ +131°F), Humidity ≤ 90% RH (non-condensing)
Dimensions (W×D×H)	205mm × 205mm × 46mm (8.1" × 8.1" × 1.8")
Weight (without HDD)	0.64kg (1.41lb)

NVR-108LS-P8



Key Features

- Support Ultra 265/H.265/H.264 video formats
- 8-channel input
- Third-party IP cameras supported with ONVIF conformance: Profile S, Profile G, Profile T
- Support 1-ch HDMI, 1-ch VGA
- HDMI and VGA simultaneous output
- Up to 5MP resolution recording
- 1 SATA HDD up to 10 TB
- Support cloud upgrade

Dimensions

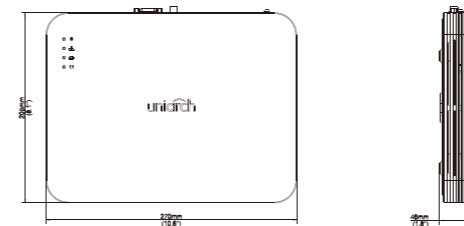

Rear Panel

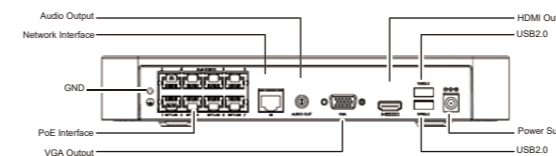

Specifications

Model	NVR-108LS-P8
Video/Audio Input	
IP Video Input	8-ch
Network	
Incoming Bandwidth	50Mbps
Outgoing Bandwidth	40Mbps
Remote Users	128
Protocols	P2P, NTP, DHCP, PPPoE
Video/Audio Output	
HDMI/VGA Output	HDMI: 1920x1080p/60Hz, 1920x1080p/50Hz, 1600x1200/60Hz, 1280x1024/60Hz, 1280x720/60Hz, 1024x768/60Hz VGA: 1920x1080p/60Hz, 1920x1080p/50Hz, 1600x1200/60Hz, 1280x1024/60Hz, 1280x720/60Hz, 1024x768/60Hz
Recording Resolution	5MP/4MP/3MP/1080p/960p/720p/D1/2CIF/CIF
Synchronous Playback	8-ch
Corridor Mode Screen	3/4/5/7/9
Decoding	
Decoding format	Ultra 265/H.265/H.264
Liveview/Playback	5MP/4MP/3MP/1080p/960p/720p/D1/2CIF/CIF
Capability	1 x 5MP@30, 2 x 4MP@25, 2 x 3MP@30, 4 x 1080p@25, 8 x 960p@25, 8 x 720p@30
Hard Disk	
SATA	1 SATA interface
Capacity	up to 10TB for each disk
External Interface	
Network Interface	1 RJ45 10M/100M self-adaptive Ethernet Interface
USB Interface	Rear panel: 2 x USB2.0
Supported Standard	IEEE 802.3at, IEEE 802.3af
External Interface	
Interface	8 independent 100 Mbps PoE network interfaces
Max Power	Max 30W for single port Max 108W in total (13.5W for each)
Supported Standard	IEEE 802.3at, IEEE 802.3af
General	
Power Supply	52V DC Power Consumption: ≤9 W (without HDD)
Working Environment	-10°C ~ +55°C (+14°F ~ +131°F), Humidity ≤ 90% RH (non-condensing)
Dimensions (W×D×H)	270mm × 205mm × 45mm (10.6"×8.1"×1.6")
Weight (without HDD)	0.8kg (1.76 lb)

NVR-E2 Series



Key Features

- Support Ultra 265/H.265/H.264 video formats
- 4/10-channel input
- Third-party IP cameras supported with ONVIF conformance: Profile S, Profile G, Profile T
- Support 1-ch HDMI, 1-ch VGA
- HDMI and VGA simultaneous output
- Up to 8MP resolution recording
- 1 SATA HDD, up to 6TB
- Support cloud upgrade

Dimensions

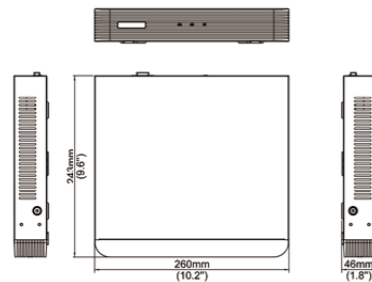

Rear Panel

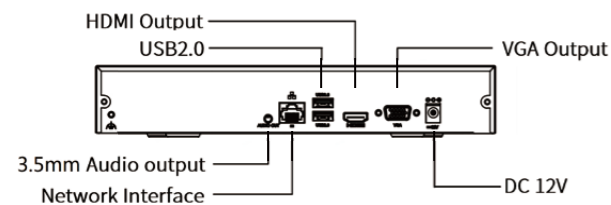

Specifications

Model	NVR-104E2	NVR-110E2
Video/Audio Input		
IP Video Input	4-ch	10-ch
Network		
Incoming Bandwidth	80Mbps	
Outgoing Bandwidth	50Mbps	
Remote Users	128	
Protocols	P2P, UPnP, DHCP	
Video/Audio Output		
HDMI/VGA Output	HDMI:3840X2160/30Hz, 1920x1080p/60Hz, 1920x1080p/50Hz, 1600x1200/60Hz, 1280x1024/60Hz, 1280x720/60Hz, 1024x768/60Hz VGA:1920x1080p/60Hz, 1920x1080p/50Hz, 1600x1200/60Hz, 1280x1024/60Hz, 1280x720/60Hz, 1024x768/60Hz	
Recording Resolution	8MP/5MP/4MP/3MP/1080P/960P/720P/960H/D1/2CIF/CIF/QCIF	
Audio Output	1-ch, 3.5mm	
Synchronous Playback	4-ch	10-ch
Corridor Mode Screen	3/4	3/4/5/7/9/10
Decoding		
Decoding format	Ultra 265/H.265/H.264	
Liveview/Playback	8MP/5MP/4MP/3MP/1080P/960P/720P/960H/D1/2CIF/CIF/QCIF	
Capability	1 x 8MP@30, 1 x 5MP@30, 2 x 4MP@30, 4 x 3MP@20, 4 x 1080p@30, 8 x 720p@30, 10 x D1@30	
Hard Disk		
SATA	1 SATA interface	
Capacity	up to 6TB for each disk	
External Interface		
Network Interface	1 RJ45 10M/100M self-adaptive Ethernet Interface	
USB Interface	Rear panel: 2 x USB2.0	
General		
Power Supply	12V DC Power Consumption: ≤3W (without HDD)	
Working Environment	-10°C~+55°C (+14°F~+131°F), Humidity ≤ 90% RH (non-condensing)	
Dimensions (W×D×H)	255mm × 215mm × 45mm (10.0" × 8.5" × 1.8")	
Weight (without HDD)	≤1.2kg (2.64lb)	

NVR-116E2



Key Features

- Support Ultra 265/H.265/H.264 video formats
- 16-channel input
- Up to 8MP resolution recording
- Support 1-ch HDMI, 1-ch VGA
- HDMI and VGA simultaneous output
- 1 SATA HDD up to 6 TB
- Support cloud upgrade

Dimensions

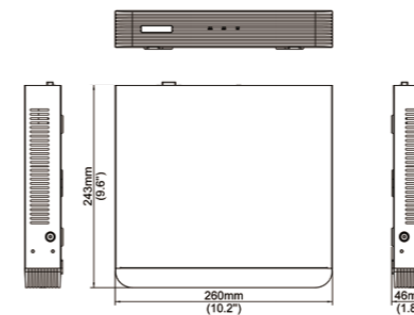

Rear Panel

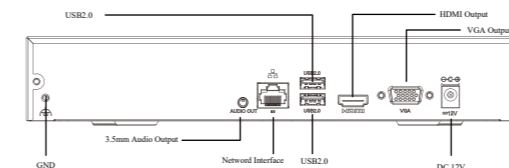

Specifications

Model	NVR-116E2
Video/Audio Input	
IP Video Input	16-ch
Network	
Incoming Bandwidth	64Mbps
Outgoing Bandwidth	32Mbps
Remote Users	128
Protocols	P2P, UPnP, DHCP
Video/Audio Output	
HDMI/VGA Output	VGA:1024X768@60,1280X720@60,1280X1024@60,1600X1200@60, 1920X1080@50, 1920X1080@60 HDMI:1024X768@60,1280X720@60,1280X1024@60,1600X1200@60, 1920X1080@50, 1920X1080@60,3840X2160@30
Recording Resolution	8MP/6MP/5MP/4MP/3MP/1080p/960p/720p/D1/2CIF/CIF
Audio Output	1-ch, 3.5mm
Synchronous Playback	16-ch
Corridor Mode Screen	3/4/5/7/9/10/12/16
Decoding	
Decoding format	H.265/H.264
Liveview/Playback	8MP/6MP/5MP/4MP/3MP/1080p/960p/720p/D1/2CIF/CIF
Capability	1 x 8MP@30, 1 x 5MP@30, 2 x 4MP@30, 4*3MP@25, 4 x 1080p@30, 8 x 720p@30, 16 x D1@25
Hard Disk	
SATA	1 SATA interface
Capacity	up to 6TB for each disk
External Interface	
Network Interface	1 RJ45 10M/100M self-adaptive Ethernet Interface
USB Interface	Rear panel: 2 x USB2.0
General	
Power Supply	12V DC Power Consumption: ≤3.2 W (without HDD)
Working Environment	-10°C~+55°C (+14°F~+131°F), Humidity ≤ 90% RH (non-condensing)
Dimensions (W×D×H)	260mm × 243mm × 46mm (10.2" × 9.6" × 1.8")
Weight (without HDD)	≤1kg (2.2lb)

NVR-E2-P Series



Key Features

- Support Ultra 265/H.265/H.264 video formats
- 4/8-channel input
- Plug & Play with 4/8 independent PoE network interfaces
- Third-party IP cameras supported with ONVIF conformance: Profile S, Profile G, Profile T
- Support 1-ch HDMI, 1-ch VGA
- HDMI and VGA simultaneous output
- Up to 8MP resolution recording
- 1 SATA HDD up to 6TB
- Support cloud upgrade

Dimensions

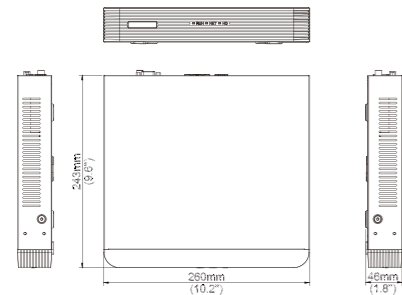

Rear Panel

Take NVR-104E2-P4 for example

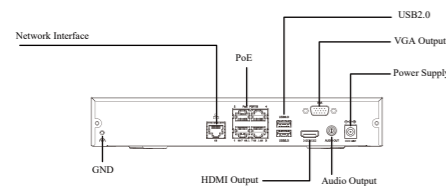

Specifications

Model	NVR-104E2-P4	NVR-108E2-P8
Video/Audio Input		
IP Video Input	4-ch	8-ch
Network		
Incoming Bandwidth	40Mbps	50Mbps
Outgoing Bandwidth	40Mbps	40Mbps
Remote Users	128	
Protocols	P2P, UPnP, DHCP	
Video/Audio Output		
HDMI/VGA Output	HDMI:3840x2160/30Hz, 1920x1080/60Hz, 1920x1080/50Hz, 1600x1200/60Hz, 1280x1024/60Hz, 1280x720/60Hz, 1024x768/60Hz VGA:1920x1080/60Hz, 1920x1080/50Hz, 1600x1200/60Hz, 1280x1024/60Hz, 1280x720/60Hz, 1024x768/60Hz	
Audio Output	1-ch, RCA	
Recording Resolution	8MP/5MP/4MP/3MP/1080P/960P/720P/960H/D1/2CIF/CIF	
Synchronous Playback	4-ch	8-ch
Corridor Mode Screen	3/4	3/4/5/7/9
Decoding		
Decoding format	Ultra 265/H.265/H.264	
Liveview/Playback	8MP/5MP/4MP/3MP/1080P/960P/720P/960H/D1/2CIF/CIF	
Capability	1 x 8MP@30, 1 x 5MP@30, 2 x 4MP@30, 4 x 3MP@25, 4 x 1080p@30, 8 x 720p@30	
Hard Disk		
SATA	1 SATA interface	
Capacity	up to 6TB for each disk	
External Interface		
Network Interface	1 RJ45 10M/100M self-adaptive Ethernet Interface	
USB Interface	Rear panel: 2 x USB2.0	
PoE		
Interface	4 RJ45 10M/100M self-adaptive Ethernet Interface	8 RJ45 10M/100M self-adaptive Ethernet Interface
Max Power	Max 30W for single port Max 54W in total	Max 30W for single port Max 75W in total
Supported Standard	IEEE 802.3at, IEEE 802.3af	
General		
Power Supply	48V DC Power Consumption: ≤9 W (without HDD)	52V DC Power Consumption: ≤9 W (without HDD)
Working Environment	-10°C~+55°C (+14°F~+131°F), Humidity ≤ 90% RH (non-condensing)	
Dimensions (W×D×H)	260mm × 243mm × 46mm (10.2" × 9.6" × 1.8")	
Weight (without HDD)	≤1.2kg (2.65lb)	

NVR-S2 Series



Key Features

- Support Ultra 265/H.265/H.264 video formats
- 8/16-channel input
- Support mainstream cameras of ONVIF conformance (Profile S, Profile G, Profile T) and RTSP protocols
- Support HDMI and VGA simultaneous output
- Up to 8 Megapixels resolution recording
- 2 SATA HDDs, up to 6TB for each HDD
- Support cloud upgrade

Dimensions

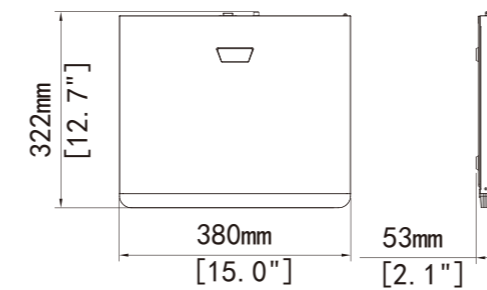

Rear Panel

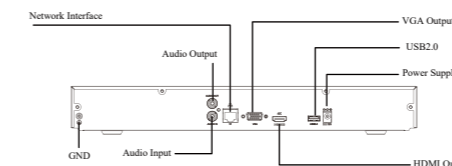

Specifications

Model	NVR-208S2	NVR-216S2
Video/Audio Input		
IP Video Input	8-ch	16-ch
Two-way Audio Input	1-ch, RCA	
Network		
Incoming Bandwidth	160Mbps	
Outgoing Bandwidth	96Mbps	
Remote Users	128	
Protocols	TCP/IP, P2P, UPnP, DHCP, HTTP, HTTPS, DNS, DDNS, SMTP	
Video/Audio Output		
HDMI/VGA Output	VGA:1024x768@60, 1280x720@60, 1280x1024@60, 1600x1200@60, 1920x1080@50, 1920x1080@60 HDMI:1024x768@60, 1280x720@60, 1280x1024@60, 1600x1200@60, 1920x1080@50, 1920x1080@60, 4K(3840x2160@30)	
Recording Resolution	8MP/6MP/5MP/4MP/3MP/1080p/960p/720p/D1/2CIF/CIF	
Audio Output	1-ch, RCA	
Audio Compression	G.711A, G.711U	
Synchronous Playback	8-ch	16-ch
Live View Display	1/4/6/8/9	1/4/6/8/9/16
Corridor Mode Screen	3/4/5/7/9	3/4/5/7/9/10/12/16
Decoding		
Decoding format	Ultra 265/H.265/H.264	
Live view/Playback	8MP/6MP/5MP/4MP/3MP/1080p/960p/720p/D1/2CIF/CIF	
Capability	1 x 4K@30, 2 x 4MP@30, 3 x 3MP@25, 4 x 1080P@30, 8 x 720P@30	1 x 4K@30, 2 x 4MP@30, 3 x 3MP@25, 4 x 1080P@30, 8 x 720P@30, 16 x D1
Hard Disk		
SATA	2 SATA interfaces	
Capacity	up to 6TB for each disk	
Smart		
VCA Detection by Camera	Intrusion Detection, Cross Line Detection, Enter Area, Leave Area	
VCA Search	Behavior Search	
Smart Intrusion Prevention (SIP) by Camera	4-ch	
General Alarm		
General Alarm	Motion, Human Body Detection, Video Loss, Alarm Input	
Alert Alarm	IP Conflict, Network Disconnected, Disk Offline, Disk Abnormal, Illegal Access	
External Interface		
Network Interface	1 RJ-45 10M/100M/1000M self-adaptive Ethernet Interface	
USB Interface	Front panel: 1 x USB2.0, Rear panel: 1 x USB2.0	
RS232	NA	
RS485	NA	
Alarm In	NA	
Alarm Out	NA	
General		
Power Supply	12V DC Power Consumption: ≤7 W (without HDD)	
Working Environment	-10°C~+ 55°C (+14°F~+131°F), Humidity ≤ 90% RH (non-condensing)	
Dimensions (W×D×H)	380mm × 322mm × 53mm (15.0" × 12.7" × 2.1")	
Weight (without HDD)	≤1.6kg (3.53lb)	
Certification		
Certification	CE; FCC; RoHS; WEEE	

NVR-S2-P Series



Key Features

- Support Ultra 265/H.265/H.264 video formats
- 816-channel input
- Plug & Play with 8/16 independent PoE network interfaces
- Support mainstream cameras of ONVIF conformance (Profile S, Profile G, Profile T) and RTSP protocols
- Support HDMI and VGA simultaneous output
- Up to 8 Megapixels resolution recording
- 2 SATA HDDs, up to 10TB for each HDD
- Support cloud upgrade

Dimensions

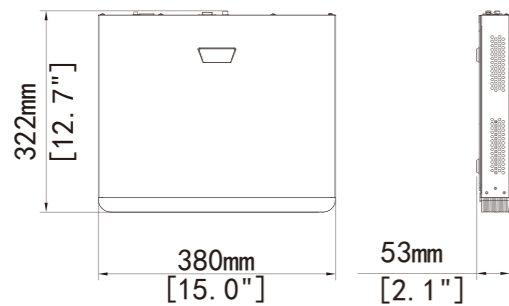

Rear Panel

Take NVR-208S2-P8 for example

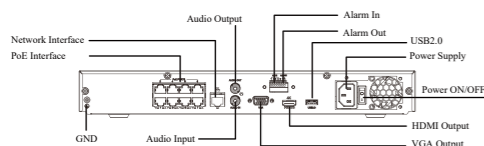

Specifications

Model	NVR-208S2-P8	NVR-216S2-P16
Video/Audio Input		
IP Video Input	8-ch	16-ch
Two-way Audio Input	1-ch, RCA	
Network		
Incoming Bandwidth	160Mbps	
Outgoing Bandwidth	96Mbps	
Remote Users	128	
Protocols	TCP/IP, P2P, UPnP, DHCP, HTTP, HTTPS, DNS, DDNS, SMTP	
Video/Audio Output		
HDMI/VGA Output	VGA:1024X768@60, 1280X720@60, 1280X1024@60, 1600X1200@60, 1920X1080@50, 1920X1080@60 HDMI:4K(3840x2160@30), 1024X768@60, 1280X720@60, 1280X1024@60, 1600X1200@60, 1920X1080@50, 1920X1080@60	
Recording Resolution	8MP/6MP/5MP/4MP/3MP/1080p/960p/720p/D1/2CIF/CIF	
Audio Output	1-ch, RCA	
Audio Compression	G.711A, G.711U	
Synchronous Playback	8-ch	16-ch
Live View Display	1/4/6/8/9	1/4/6/8/9/16
Corridor Mode Screen	3/4/5/7/9	3/4/5/7/9/10/12/16
Decoding		
Decoding format	Ultra 265/H.265/H.264	
Live view/Playback	8MP/6MP/5MP/4MP/3MP/1080p/960p/720p/D1/2CIF/CIF	
Capability	1 x 4K@30, 2 x 4MP@30, 3 x 3MP@25, 4 x 1080P@30, 8 x 720P@30	1 x 4K@30, 2 x 4MP@30, 3 x 3MP@25, 4 x 1080P@30, 8 x 720P@30, 16 x D1
Hard Disk		
SATA	2 SATA interfaces	
Capacity	up to 10TB for each disk	
Smart		
VCA Detection by Camera	Intrusion Detection, Cross Line Detection, Enter Area, Leave Area	
VCA Search	Behavior Search	
Smart Intrusion Prevention (SIP) by Camera	4-ch	
General Alarm		
General Alarm	Motion, Human Body Detection, Video Loss, Alarm Input	
Alert Alarm	IP Conflict, Network Disconnected, Disk Offline, Disk Abnormal, Illegal Access	
External Interface		
Network Interface	1 RJ-45 10M/100M/1000M self-adaptive Ethernet Interface	
USB Interface	Front panel: 1 x USB2.0, Rear panel: 1 x USB2.0	
RS232	NA	
RS485	NA	
Alarm In	4-ch	
Alarm Out	1-ch	
General		
Power Supply	220V AC Power Consumption: ≤9 W (without HDD)	
Working Environment	-10°C~+55°C (+14°F~+131°F), Humidity ≤ 90% RH (non-condensing)	
Dimensions (WxDxH)	380mm x 322mm x 53mm (15.0" x 12.7" x 2.1")	
Weight (without HDD)	≤2.4kg (5.29lb)	
Certification		
Certification	CE; FCC; RoHS; WEEE	

XVR-G3 Series

XVR-G3



Key Features

- Support H.265/H.264 video formats
- Support audio over coaxial cable
- Support TVI, AHD, CVI, CVBS, IP cameras with adaptive access
- 4/8-channel BNC input
- Support 1-ch HDMI output, 1-ch VGA output at up to 1920*1080
- Long transmission distance over coax cable
- Supports mainstream cameras of ONVIF and RTSP protocols

Dimensions

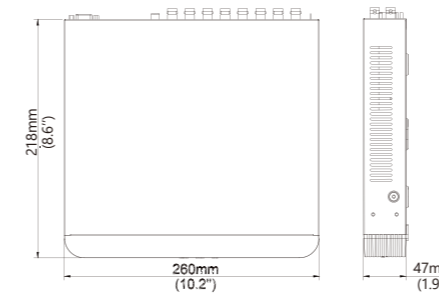

Rear Panel

Take XVR-108G3 for example

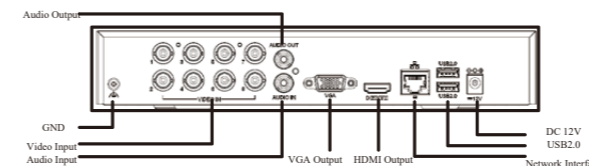

Specifications

Model	XVR-104G3	XVR-108G3		
Video/Audio Input				
Analog Video Input	4-ch, BNC	8-ch, BNC		
IP Video Input	2-ch (only IP up to 6ch), each channel up to 4MP	4-ch (only IP up to 8ch), each channel up to 4MP		
Supported Analog Camera Types	5MP@20fps 4MP@30fps 1080P@30fps	5MP@12fps 4MP@15fps 1080P@30fps		
Audio Input	1-ch, RCA			
Network				
Incoming Bandwidth	16Mbps (Up to 24Mbps)	32Mbps (Up to 40Mbps)		
Outgoing Bandwidth	48Mbps	64Mbps		
Remote Users	128			
Protocols	TCP/IP, P2P, UPnP, DHCP, HTTP, HTTPS, DNS, DDNS, SMTP			
Video/Audio Output				
VGA Output	1920x1080/60Hz, 1920x1080/50Hz, 1600x1200/60Hz, 1280x720/60Hz, 1024x768/60Hz			
HDMI Output	HDMI Output 1920x1080/60Hz, 1920x1080/50Hz, 1600x1200/60Hz, 1280x1024/60Hz, 1280x720/60Hz, 1024x768/60Hz			
Audio Output	1-ch, RCA			
Synchronous Playback	HD:1-ch SD:4-ch	HD:4-ch SD:8-ch		
Two-way Audio	1-ch, RCA	1-ch, RCA		
Encoding				
Recording Frame Rate	Main stream: 5MP Lite@12fps 4MP Lite@15fps 1080P@15fps	Sub stream: D1@12fps D1@15fps D1@15fps	Main stream: 5MP Lite@6fps 4MP Lite@15fps 1080P Lite@12fps	Sub stream: D1@6fps D1@8fps D1@12fps
Hard Disk				
SATA	1 SATA interface			
Capacity	Up to 6TB for each HDD			
General Alarm				
SATA	By analog camera: Motion detection By IP Camera: Motion detection/Face detection			
Alert Alarm	IP Conflict, Network Disconnected, Disk offline, Disk Abnormal, Illegal Access			
External Interface				
SATA	1 SATA interface			
USB Interface	Rear panel: 2 x USB2.0			
General				
Power Supply	12V DC Power Consumption: ≤8 W (without HDD)			
Dimensions (WxDxH)	Rear panel: 2 x USB2.0			
Weight (without HDD)	≤1.1 Kg (2.42lb)			

24" LED FHD Monitor

MT-24-L



Key Features

- True color display and perfect color reproduction
- Wide viewing angle: 178°(H)/ 178°(V)
- No color shift from any view angle
- Specific menu design, which is simple to operate
- Support 7*24 working and lower power consumption
- Adaptively recognize signal
- VESA stand bracket
- Support multiply language
- High fidelity digital processing for a brilliant and vivid video
- Professional thermal design to extend equipment lifespan
- Screen can reduce blue light, protect eyes
- Without ripple, use smooth dimming with DC to eliminate screen flicker
- Three sides super slim design, min width can be 2.8mm
- High light transmittance, uniform brightness, rich color, wide color gamut

Dimensions

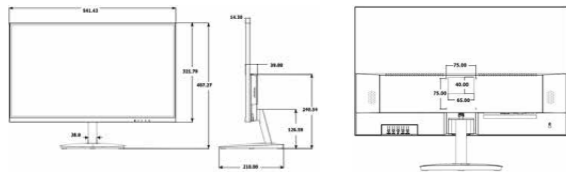

Interfaces

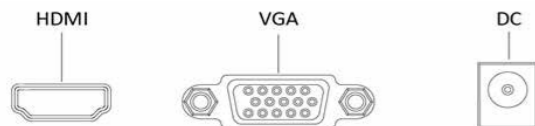

Specifications

Model	MT-24-T
Display	
Display Type	LED Backlight
Screen Size	23.8"
Aspect Ratio	16:9
Pixel Pitch (mm)	0.275× 0.275
Max Resolution	1920×1080
Brightness (cd/m2)	250
Contrast	1000:1
Response Time (ms)	14
Color	16.7M
Viewing Angle	Horizontal 178°, Vertical 178°
Refresh Rate	60Hz
Interface	
Input	VGA × 1, HDMI × 1
OSD	
Multi-Language	8 (English, France, Spanish, German, Russia, Korea, Japanese, Simplified Chinese)
Mounting	
VESA	75mm × 75mm
General	
Power Supply	DC 12V, 2A
Consumption	<23W (on) <0.5W (Standby)
Operation Temperature	0°C ~ 40 °C/32°F~104°F
Operating Humidity	20%~85% (No Condensation)
Storage Temperature	-10°C ~50°C/14°F~122°F
Storage Humidity	10%~90% (No Condensation)
Dimension (W×H×D)	541.43mm × 407.27 mm × 210.00mm (With Pedestal)
Package (W×H×D)	602mm × 394mm × 111mm
Weight	Net Weight: 3.3Kg Gross Weight: 4.2Kg
Accessory	
Standard	HDMI Cable, Adapter, Pedestal, Quick Guide
Optional	Hanging Bracket (Model: HB-4022-A)

22" LED FHD Monitor

MT-22-L



Key Features

- True color display
- Resolution is up to at 1920×1080
- Wide view of field: 178°(H)/ 178°(V)
- Specific menu design, which is simple to operate
- Support 7*24 working and lower power consumption
- Adaptively recognize signal
- VESA stand bracket
- Support multiply language

Dimensions

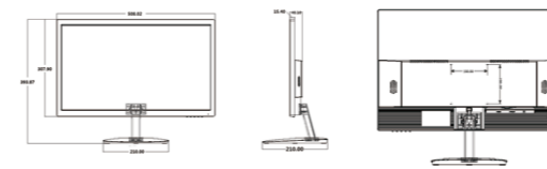

Interfaces

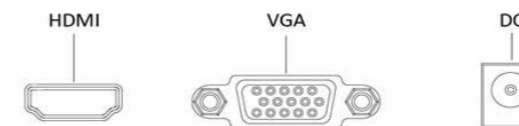

Specifications

Model	MT-22-L
Display	
Display Type:	LED Backlight
Screen Size	21.5 Inch
Pixel Pitch(mm)	0.265(H)× 0.24825(V)
Max Resolution	1920×1080
Brightness (cd/m2)	250
Contrast	4000:1
Response Time (ms)	6.5
Color	16.7M
Viewing Angle	Horizontal 178°, Vertical 178°
Refresh Rate	60Hz
Interface	
VGA	1
HDMI	1
OSD	
Multi-Language	8 (English, France, Spanish, German, Russia, Korea, Japanese, Simplified Chinese)
Mounting	
VESA	100mm x 100mm
General	
Power Supply	DC 12V, 2A
Consumption	<23W (on) <0.5W (Standby)
Operation Temperature	0°C ~ 40 °C/32°F ~104°F
Operating Humidity	20%~85% (No Condensation)
Storage Temperature	-10°C ~ 50°C/14°F ~122°F
Storage Humidity	0%~90% (No Condensation)
Dimension (W×H×D)	508.02mm × 393.87mm × 210.00mm (With Pedestal)
Package(W×H×D)	570mm × 395mm × 118mm
Weight	Net Weight: 2.51Kg Gross Weight: 3.3Kg
Accessory	
Standard	HDMI Cable, Adapter, Pedestal, Quick Guide
Optional	Hanging Bracket (Model: HB-4022-A)

6-Port PoE Switch

SW-2106-P



Introduction

SW-2106-P provides the seamless network connection. The PoE ports (Port1~4) can automatically detect and supply power with those IEEE 802.3 af/at compliant Powered Devices (PD). The electrical power is transmitted along with data in one single cable allowing you to expand your network where there are no power lines or outlets, where you wish to fix devices such as AP, IP Cameras or IP Phones, etc.

It is easy to install and it doesn't need configuration. With outstanding performance and quality, the 6-port 10/100Mbps desktop PoE switch is an ideal choice for expanding your home or office network.

Key Features

- Multiple working modes to address your business needs: Normal, Secure and Surveillance
- Support port traffic control
- Support for secure mode, all downlink ports can communicate only with uplink ports
- Up to 250m transmission distance on surveillance mode
- Support buffer optimization
- All metal housing, safe and reliable

Specifications

Model	SW-2106-P
Ports	6x100Mbps network ports (RJ45), including 4 PoE ports
Standards	IEEE802.3, IEEE802.3u, IEEE802.3az, IEEE802.3x, IEEE802.3af, IEEE802.3at
Switching capacity	1.2Gbps
Forwarding performance	0.90Mpps
Packet Buffer	768Kbit
MAC	2K
Dimensions (WxDxH)	160mm x 93mm x 32mm (6.3"x3.7"x1.3")
Weight	<0.6kg
Power supply	AC: 100-240V, 50/60Hz
PoE	802.3at/af
Max. PoE Power	Max capacity: 65W
	Max capacity for single port: 30W
Cooling Fans	0
Mean Time Between Failure (MTBF)	>50000 hours
Operating temperature	0°C-40°C (32°F-104°F)
Operating humidity	10%-90% (noncondensing)
Storage humidity	5%-90% (noncondensing)
Indicator	PWR: Steady on: AC input is normal Off: No AC input
	PoE: Off: No PoE power supply Steady on: PoE power supply is normal Flashing: PoE power supply is abnormal
	LINK/ACT: Off: No link Steady: Linked at 10/100Mbps Flashing: Transmitting data
	Speed: Off: Linked at 10/100Mbps On: Linked at 1000Mbps
Working Mode	Default (Normal mode): All ports can communicate with each other EXTEND (Surveillance mode): Transmission distance up to 250 meters

10-Port PoE Switch

SW-2110-P



Introduction

SW-2110-P is Fast uplink Switch which provides you with a high-performance, low-cost, easy-to-use, seamless and standard upgrade to boost your old network to 100Mbps. Increase the speed of your network server and backbone connections, making Gigabit connection to a server or uplink a network necessarily.

Its PoE ports can automatically detect and supply power with those IEEE 802.3af/at compliant Powered Devices (PD).

The electrical power is transmitted along with data in one single cable allowing you to expand your network where there are no power lines or outlets, where you wish to fix devices such as AP, IP Cameras or IP Phones, etc.

Key Features

- Multiple working modes to address your business needs: Normal, Secure and Surveillance
- Support port traffic control
- Support for secure mode, all downlink ports can communicate only with uplink ports
- Up to 250m transmission distance on surveillance mode
- Support buffer optimization
- All metal housing, safe and reliable

Specifications

Model	SW-2110-P
Ports	10x100Mbps network ports (RJ45), including 8 PoE ports
Standards	IEEE802.3, IEEE802.3u, IEEE802.3az, IEEE802.3x, IEEE802.3af, IEEE802.3at
Switching capacity	2Gbps
Forwarding performance	1.49Mpps
Packet Buffer	2Mbit
MAC	8K
Dimensions (WxDxH)	220mm x 150mm x 44mm (8.7"x5.9"x1.7")
Weight	<1.22kg
Power supply	AC: 100-240V, 50/60Hz
PoE	802.3at/af
Max. PoE Power	Max capacity: 120W
	Max capacity for single port: 30W
Cooling Fans	0
Mean Time Between Failure (MTBF)	>50000 hours
Operating temperature	0°C-40°C (32°F-104°F)
Operating humidity	10%-90% (noncondensing)
Storage humidity	5%-90% (noncondensing)
Indicator	PWR: Steady on: AC input is normal Off: No AC input
	PoE: Off: No PoE power supply Steady on: PoE power supply is normal Flashing: PoE power supply is abnormal
	LINK/ACT: Off: No link Steady: Linked at 10/100Mbps Flashing: Transmitting data
	Speed: Off: Linked at 10/100Mbps On: Linked at 1000Mbps
Working Mode	Default (Normal mode): All ports can communicate with each other VLAN (Secure mode): Downlink ports can communicate only with uplink ports EXTEND (Surveillance mode): Transmission distance up to 250 meters

Network Cable

UTP Category 5E Cables

Specifications

Content of Data Sheet			
Product model	CAB-5E-A/CAB-5E-B		
Product specification	HSYV-5e 4×2×0.50		
Test Standard	YD/T1019-2013		
Conductor	Material	Solid-Bare Copper	
	AWG	24	
	Nom.O.D.(mm)	0.5±0.01 mm	
	DC resistance	≤95 Ω/km	
Insulation	Material	HDPE	
	Thickness	0.2±0.02 mm	
	Diameter	0.9±0.05 mm	
	Color	Blue/White- Blue Orange/White-Orange	Green/White-Green Brown/White-Brown
Pitch	Offset pitch	≤25 mm	
	Cable pitch	≤140 mm	
Sheath	Material	PVC(complies RoHS/REACH)	
	External O.D.	5.1±0.3 mm	
	Color	Gray(RAL7046)	
	Tensile strength	>13.5 Mpa	
	Thickness	0.55±0.05 mm	
Surface Printing	Letter height	3.0±0.3 mm	
	Color	Black	
	Print error & Space	1±0.005 m	
	Case number	Yes	
Packing	Packing	Carton	
	Once packing dimension	350mm*216mm*350mm	
	Twice packing dimension	370mm*460mm*370mm	
	Twice packing quantity	2 cases	
Packing length	305±1 m		
Rip-cord	Yes		
Ambient temperature	-20°C~60°C		

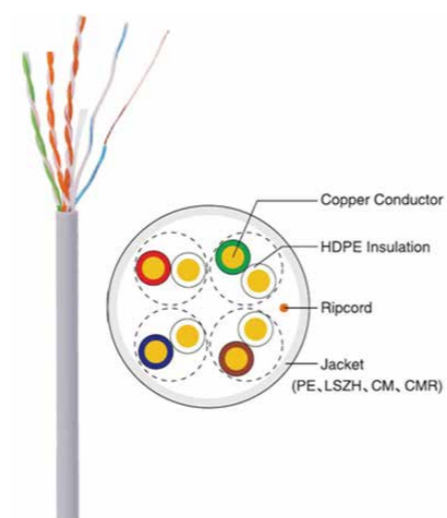

Electrical Characteristics:

Frequency	Characteristic impedance	RL	ATT	NEXT
MHz	ohm	≥dB/100m	≤dB/100m	≥dB/100m
1	100±15	20.0	2.0	65.3
4	100±15	23.0	4.1	56.3
10	100±15	25.0	6.5	50.3
16	100±15	25.0	8.2	47.3
20	100±15	25.0	9.3	45.8
31.25	100±15	23.6	11.6	42.9
62.5	100±15	21.5	17.0	38.4
100	100±15	20.1	22.0	35.3

Frequency	FEXT	PS NEXT	PS FEXT	Phase delay
MHz	≥dB/100m	≥dB/100m	≥dB/100m	≤ns/100m
1	63.8	62.3	60.8	570.0
4	51.7	53.3	48.7	552.0
10	43.8	47.3	40.8	545.4
16	39.7	44.2	36.7	543.0
20	37.7	42.8	34.7	542.0
31.25	33.9	39.9	30.9	540.4
62.5	27.8	35.4	24.8	538.6
100	23.8	32.3	20.8	537.4

Network Cable

UTP Category 6 Cables

Specifications

Content of Data Sheet			
Product model	CAB-6-AE/CAB-6-BE		
Product specification	HSYV-6 4×2×0.52		
Test Standard	ISO/IEC11801、TIA-568-C.2、YD/T1019		
Conductor	Material	Solid-Bare Copper	
	AWG	24	
	Nom.O.D.(mm)	0.52±0.03 mm	
	DC resistance	≤95 Ω/km	
Insulation	Material	HDPE	
	Thickness	0.2±0.02 mm	
	Diameter	0.93±0.05 mm	
	Color	Blue/White- Blue Orange/White-Orange	Green/White-Green Brown/White-Brown
Pitch	Offset pitch	≤20 mm	
	Cable pitch	≤120 mm	
Sheath	Material	PVC(complies RoHS/REACH)	
	External O.D.	5.8±0.3 mm	
	Color	Orange	
	Tensile strength	>13.5 Mpa	
	Thickness	0.6±0.05 mm	
Surface Printing	Letter height	3.0±0.3 mm	
	Color	Black	
	Print error & Space	1±0.005 m	
	Case number	Yes	
Packing	Packing	Carton	
	Once packing dimension	420mm*205mm*420mm	
	Twice packing dimension	450mm*440mm*445mm	
	Twice packing quantity	2 cases	
Packing length	305±1 m		
Rip-cord	Yes	Crossing backbone	Yes
Ambient temperature	-20°C~60°C		

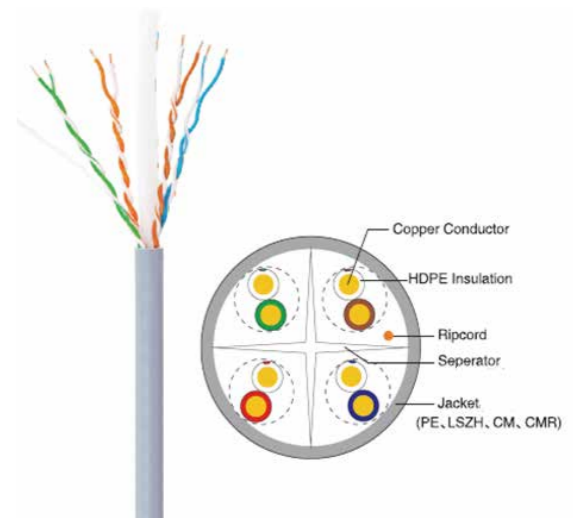

Network Cable

UTP Category 6 Cables CCA

Specifications

Content of Data Sheet

Product model	CAB-6-CCA		
Product specification	HSYV-6 4×2×0.585		
Conductor	Material	CCA(Copper content:27%)	
	AWG	23	
	Nom.O.D.(mm)	0.585±0.05 mm	
	DC resistance	<12Ω/100m	
	Material	HDPE	
Insulation	Thickness	0.2±0.02 mm	
	Diameter	1.05±0.05 mm	
	Color	Blue/White- Blue	Green/White-Green
		Orange/White-Orange	Brown/White-Brown
Pitch	Offset pitch	≤20 mm	
	Cable pitch	≤120 mm	
	Material	PVC	
Sheath	External O.D.	6.2±0.3 mm	
	Color	White	
	Tensile strength	>13.5 Mpa	
	Thickness	0.5±0.05 mm	
	Letter height	3.0±0.3 mm	
Surface Printing	Color	Black	
	Print error & Space	1±0.005 m	
	Case number	Yes	
	Packing	Carton	
Packing	Once packing dimension	310mm*310mm*190mm	
	Twice packing dimension	400mm*330mm*330mm	
	Twice packing quantity	2	
Packing length	100±1m		
Rip-cord	Yes	Crossing backbone	Yes
Ambient temperature	-20 C ~ 60 C		

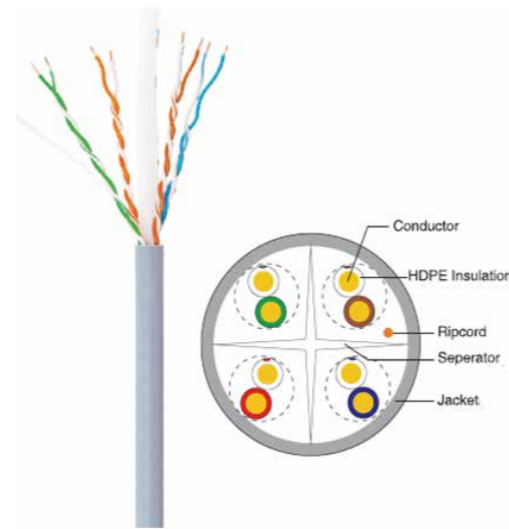

Smart Office

- Uniarch smart office products enable people to break the barrier of location and increase the global workforce.
- With several audio and video core technologies, Unear video conferencing product is able to give users perfect meeting experience.

All-In-One Video Conference Camera

Unear A30(T)

An ideal all-in-one solution for small-to-medium sized teams.



All-In-One Design



AI Noise Suppression



5-Meter Effective Voice Pickup Range



Full-Duplex Mode



Echo cancellation



Ultra Wide-Angle



HD Resolution



Unear A30T Unear A30

2MP All-In-One Video Conference Camera

IoT-Unear A30T



Key Features

- Omnidirectional 4 microphones array algorithm, 5-meter far-field clear voice pickup
- Exclusive AI noise-suppression technology, significantly increase concentration of conference participants
- Real full-duplex, HQ uninterrupted communication
- 100° full HD wide-angle camera, in-person conference experience
- Plug & play, general compatibility with leading online conference platforms
- Audio & video all-in-one, intuitive control experience

Dimensions

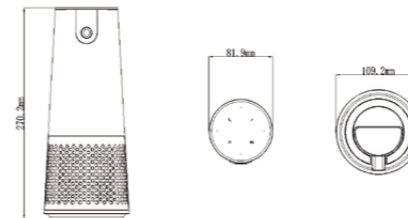

Specifications

Features	IoT-Unear A30T
Wide-Angle Camera	100° Ultra Wide-Angle
High-Quality Wideband Speaker	Supported
Clear Uninterrupted Full-Duplex Communication	Supported

Image Spec	
Self-Adaptive Skin Toning	Supported
Lens Distortion Correction	Supported
Anti-Flickering	Supported
Automatic Exposure	Supported
Automatic White Balance	Supported
3D Denoise	Supported

Video Specs	
Video Output	FHD 1080P@30fps
Aspect Ratio	16:9
UVC Compatibility	1.1 / 1.5
Coded Format	MJPEG and YUV

Camera Specs	
Aperture	F / 2.4
Pixel	2MP
FOV(H)	100°
FOV(V)	62°
TV Distortion	< 1%

Audio Specs	
Maximum Background Noise Suppression	24dB
Full-Duplex	When the gap of acoustic intensity between the near-end and far-end is less than 50dB
Echo-Cancellation	Echo Cancellation ≥30dB
AGC	Automatic Gain Control *Within 5-Meter Range
Reverberation Suppression	RT60<1s
AI-based Speaker Detection	Supported
AI-based Noise-Suppression	Supported

Microphone Specs	
Microphones	4-Element MEMS Microphone, 360° Omnidirectional Array
Sensitivity	-32dB FS94dB SPL@1KHZ
SNR	64dBA
Effective Voice Pickup Range	5 Meters (In conference rooms with low SNR, the actual voice pickup radius can be 5 meters or less)

Speaker Specs	
Peak Power	5W
Rated Output Power	3W
Speaker Frequency Response	20Hz ~20kHz
Speaker Volume	90dB SPL @0dB 1kHz at 0.5m
THD	≤1%

Configuration Requirements	
PC Windows or Linux, Mac OS with USB Connection	Supported

Input / Output	
USB Power Supply	5V/500mA
Data Transmission over USB Type-C	Supported

Weight	
Net Weight	618g
Gross Weight	1277g

Dimension	
Product Dimensions	270mm(H)*110mm(Φ)

4MP All-In-One Video Conference Camera

IoT-Unear A30



Key Features

- Omnidirectional 4 microphones array algorithm, 5-meter far-field clear voice pickup
- Exclusive AI noise-suppression technology, significantly increase concentration of conference participants
- Real full-duplex, HQ uninterrupted communication
- 115° wide-angle distortion less camera captures all meeting participants clearly
- Plug & play, general compatibility with leading online conference platforms
- Audio & video all-in-one, intuitive control experience

Dimensions

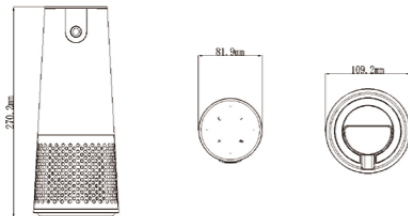

Specifications

	IoT-Unear A30
Features	
Wide-Angle Camera	115° wide-angle distortion less
High-Quality Wideband Speaker	Supported
Clear Uninterrupted Full-Duplex Communication	Supported

Image Spec	
Self-Adaptive Skin Toning	Supported
Lens Distortion Correction	Supported
Anti-Flickering	Supported
Automatic Exposure	Supported
Automatic White Balance	Supported
3D Denoise	Supported
Video Specs	
Video Output	4MP@30fps
Aspect Ratio	16:9
UVC Compatibility	1.1 / 1.5
Coded Format	MJPEG and YUV
Camera Specs	
Aperture	F / 2.2
Pixel	4MP
FOV(H)	115°
FOV(V)	59°
TV Distortion	< 1%
Audio Specs	
Maximum Background Noise Suppression	24dB
Full-Duplex	When the gap of acoustic intensity between the near-end and far-end is less than 50dB
Echo-Cancellation	Echo Cancellation ≥30dB
AGC	Automatic Gain Control *Within 5-Meter Range
Reverberation Suppression	RT60<1s
AI-based Speaker Detection	Supported
AI-based Noise-Suppression	Supported
Microphone Specs	
Microphones	4-Element MEMS Microphone, 360° Omnidirectional Array
Sensitivity	-32dB FS94dB SPL@1KHZ
SNR	64dBA
Effective Voice Pickup Range	5 Meters (In conference rooms with low SNR, the actual voice pickup radius can be 5 meters or less)
Speaker Specs	
Peak Power	5W
Rated Output Power	3W
Speaker Frequency Response	20Hz ~20kHz
Speaker Volume	90dB SPL @0dB 1kHz at 0.5m
THD	≤1%
Configuration Requirements	
PC Windows or Linux, Mac OS with USB Connection	Supported
Input / Output	
USB Power Supply	5V/500mA
Data Transmission over USB Type-C	Supported
Weight	
Net Weight	635g
Gross Weight	1260g
Dimension	
Product Dimensions	270mm(H)*110mm(Φ)

2MP All-In-One Video Conference Camera

Unear A20



Key Features

- 4 Omni-directional microphones array algorithm, 5-meter far-field clear voice pickup
- Exclusive AI noise-suppression technology, real full-duplex communication
- 90° full HD wide-angle camera, in-person conference experience
- Automatic exposure/white balance, distortion correction
- Touch button, multi-color breathing status indicator
- Sliding physical privacy protection cover
- Plug & play, general compatibility with leading online conference platforms
- Audio & video all-in-one, intuitive control experience

Dimensions

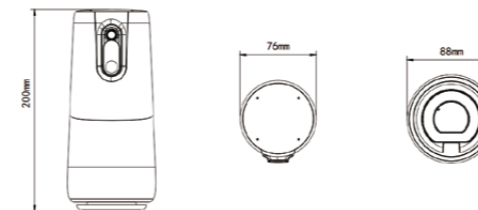

Specifications

	Unear A20
Features	
Wide-Angle Camera	90° Ultra Wide-Angle
Non-Distortion	Supported
High-Quality Wideband Speaker	Supported
Clear Uninterrupted Full-Duplex Communication	Supported
Image Spec	
Self-Adaptive Skin Toning	Supported
Lens Distortion Correction	Supported
Anti-Flickering	Supported
Automatic Exposure	Supported
Automatic White Balance	Supported
3D DNR	Supported
Video Specs	
WDR	DWDR
Video Output	MAX UP TO 1920*1080@30fps(MJPEG)
Aspect Ratio	16:9
UVC Compatibility	1.0/ 1.1
USB 2.0 Transmission	MJPEG and YUV
Camera Specs	
Aperture	F2.0
Pixel	2MP
Image	UP TO 1920*1080
FOV(H)	90°
FOV(V)	60°
TV Distortion	< 1%
Audio Specs	
Maximum Background Noise Suppression	24dB
Full-Duplex	When the gap of acoustic intensity between the near-end and far-end is less than 50dB
Echo-Cancellation	Echo Cancellation ≥30dB
AGC	Automatic Gain Control *Within 5-Meter Range
Reverberation Suppression	RT60<1s
AI-based Speaker Detection	Supported
AI-based Noise-Suppression	Supported
Microphone Specs	
Microphones	4-Element MEMS Microphone, 360° Omnidirectional Array
Sensitivity	-38dB FS94dB SPL@1KHZ
SNR	63dB
Effective Voice Pickup Range	5 Meters(In conference rooms with low SNR, the actual voice pickup radius can be 5 meters or less)
Speaker Specs	
Peak Power	3W
Speaker Frequency Response	20Hz ~20kHz
Speaker Volume	105dB SPL @0dB 2kHz at 0.1m
THD	≤ 5%
Configuration Requirements	
PC Windows or Linux, Mac OS with USB Connection	Supported
Speaker Specs	
USB Power Supply	5V/500mA
Data Transmission over USB Type-C	Supported

Webcam

Unear V20

Best webcam for a variety of flexible personal office scenarios.

 2K ultra high-resolution	 Support WDR	 Dual Noise-Canceling Mics	 Area Sound Pickup
 Privacy protection	 Multiple Installation Modes	 Ultra Wide-angle	



4MP Webcam

Unear V20



Key Features

- 1440P image quality, 90° wide angle lens
- True WDR Technology
- AI noise-suppression makes your sound more clear
- The built-in lens cover to protect your privacy
- USB plug and play

Dimensions

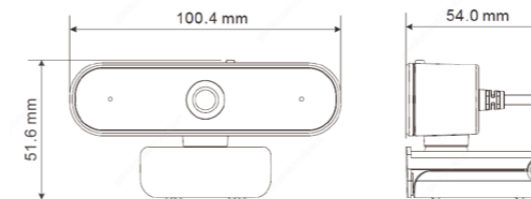

Specifications

Unear V20 Webcam	
Video Specs	
Anti-flickering	Supported
Auto exposure	Supported
Auto White balance	Supported
3D noise-suppression	Supported
WDR	Supported
Max. resolution	1440P
Aspect ratio	16:9
UVC protocol supported	UVC 1.1/1.5
Coded format	MJPEG: max to 1440P@30fps or 1080P@60fps
Camera Specs	
Aperture	f/2.3
Sensor	1/2.9 in, CMOS, 4MP
Focusing mode	3.0mm fixed-focus
FOV(D)	90°
FOV(H)	82°
FOV(V)	52°
Non-Distortion Lens	Supported
Audio Specs	
Area sound pickup range	-45°~45°
Maximum background noise suppression	15dB
Microphone Specs	
Microphone type	2-Element Microphones Array
Sensitivity	-26dBFS 94dB SPL@1kHz
S/N	65dB 94dB SPL@1kHz, A-weighted
Effective pickup distance	3 Meters
Configuration Requirements	
PC Windows or Linux, Mac OS with USB Connection	Supported
Input / Output	
USB Power Supply	5V/500mA
USB port	USB2.0 Type-A
USB 2.0	Supported
Installation	
Clip on the screen/on the tripod/on the surface	Supported
Appearance Color	
Classic black	Supported
Input / Output	
Net Weight	130g
Gross Weight	180g
Dimensions	
Product dimensions	100mm(L)*55mm(W)*50mm(H)
Package dimensions	132mm(L)*60mm(W)*110mm(H)